



INVERTER FR-E700

INSTRUCTION MANUAL (BASIC)

FR-E720-0.1KSC to 15KSC

FR-E740-0.4KSC to 15KSC

FR-E720S-0.1KSC to 2.2KSC

Thank you for choosing this Mitsubishi Inverter.
This Instruction Manual (Basic) provides handling information and precautions for use of the equipment.
Please forward this Instruction Manual (Basic) to the end user.

CONTENTS

[1] OUTLINE	1
[2] INSTALLATION AND WIRING	6
[3] PRECAUTIONS FOR USE OF THE INVERTER.....	20
[4] FAILSAFE OF THE SYSTEM WHICH USES THE INVERTER ...	22
[5] DRIVING THE MOTOR.....	23
[6] ENERGY SAVING OPERATION FOR FANS AND PUMPS	33
[7] PARAMETERS	34
[8] TROUBLESHOOTING	39
[9] PRECAUTIONS FOR MAINTENANCE AND INSPECTION	44
[10] SPECIFICATIONS.....	46



To obtain the Instruction Manual (Applied) and the Safety stop function instruction manual

Contact where you purchased the inverter, your Mitsubishi sales representative, or the nearest Mitsubishi FA Center for the following manual:

- *Instruction Manual (Applied) [IB(NA)-0600277ENG]*
- *Safety stop function instruction manual [BCN-A211508-004]*

These manuals are required if you are going to utilize functions and performance.

The PDF versions of these manuals are also available for download at "MELFANS Web," the Mitsubishi Electric FA network service on the world wide web (URL: <http://www.MitsubishiElectric.co.jp/melfansweb>).

1

2

3

4

5

6

7

8

9

10

This Instruction Manual (Basic) provides handling information and precautions for use of the equipment. Please forward this Instruction Manual (Basic) to the end user.

This section is specifically about safety matters

Do not attempt to install, operate, maintain or inspect the inverter until you have read through the Instruction Manual (Basic) and appended documents carefully and can use the equipment correctly. Do not use this product until you have a full knowledge of the equipment, safety information and instructions.

In this Instruction Manual (Basic), the safety instruction levels are classified into "WARNING" and "CAUTION".

WARNING Incorrect handling may cause hazardous conditions, resulting in death or severe injury.

CAUTION Incorrect handling may cause hazardous conditions, resulting in medium or slight injury, or may cause only material damage.

The **CAUTION** level may even lead to a serious consequence according to conditions. Both instruction levels must be followed because these are important to personal safety.

1. Electric Shock Prevention

WARNING

- While power is ON or when the inverter is running, do not open the front cover. Otherwise you may get an electric shock.
- Do not run the inverter with the front cover or wiring cover removed. Otherwise you may access the exposed high-voltage terminals or the charging part of the circuitry and get an electric shock.
- Even if power is OFF, do not remove the front cover except for wiring or periodic inspection. You may accidentally touch the charged inverter circuits and get an electric shock.
- Before wiring or inspection, power must be switched OFF. To confirm that, LED indication of the operation panel must be checked. (It must be OFF.) Any person who is involved in wiring or inspection shall wait for at least 10 minutes after the power supply has been switched OFF and check that there are no residual voltage using a tester or the like. The capacitor is charged with high voltage for some time after power OFF, and it is dangerous.
- This inverter must be earthed (grounded). Earthing (grounding) must conform to the requirements of national and local safety regulations and electrical code (NEC section 250, IEC 536 class 1 and other applicable standards). A neutral-point earthed (grounded) power supply for 400V class inverter in compliance with EN standard must be used.
- Any person who is involved in wiring or inspection of this equipment shall be fully competent to do the work.
- The inverter must be installed before wiring. Otherwise you may get an electric shock or be injured.
- Setting dial and key operations must be performed with dry hands to prevent an electric shock.
- Do not subject the cables to scratches, excessive stress, heavy loads or pinching. Otherwise you may get an electric shock.
- Do not change the cooling fan while power is ON. It is dangerous to change the cooling fan while power is ON.
- Do not touch the printed circuit board or handle the cables with wet hands. Otherwise you may get an electric shock.
- When measuring the main circuit capacitor capacity, the DC voltage is applied to the motor for 1s at powering OFF. Never touch the motor terminal, etc. right after powering OFF to prevent an electric shock.

2. Fire Prevention

CAUTION

- Inverter must be installed on a nonflammable wall without holes (so that nobody touches the inverter heatsink on the rear side, etc.). Mounting it to or near flammable material can cause a fire.
- If the inverter has become faulty, the inverter power must be switched OFF. A continuous flow of large current could cause a fire.
- When using a brake resistor, a sequence that will turn OFF power when a fault signal is output must be configured. Otherwise the brake resistor may overheat due to damage of the brake transistor and possibly cause a fire.
- Do not connect a resistor directly to the DC terminals P/+ and N/-. Doing so could cause a fire.

3. Injury Prevention

CAUTION

- The voltage applied to each terminal must be the ones specified in the Instruction Manual. Otherwise burst, damage, etc. may occur.
- The cables must be connected to the correct terminals. Otherwise burst, damage, etc. may occur.
- Polarity must be correct. Otherwise burst, damage, etc. may occur.
- While power is ON or for some time after power-OFF, do not touch the inverter as they will be extremely hot. Doing so can cause burns.

4. Additional Instructions

Also the following points must be noted to prevent an accidental failure, injury, electric shock, etc.

(1) Transportation and Mounting

CAUTION

- The product must be transported in correct method that corresponds to the weight. Failure to do so may lead to injuries.
- Do not stack the boxes containing inverters higher than the number recommended.
- The product must be installed to the position where withstands the weight of the product according to the information in the Instruction Manual.
- Do not install or operate the inverter if it is damaged or has parts missing.
- When carrying the inverter, do not hold it by the front cover or setting dial; it may fall off or fail.
- Do not stand or rest heavy objects on the product.
- The inverter mounting orientation must be correct.
- Foreign conductive objects must be prevented from entering the inverter. That includes screws and metal fragments or other flammable substance such as oil.
- As the inverter is a precision instrument, do not drop or subject it to impact.
- The inverter must be used under the following environment. Otherwise the inverter may be damaged.

Environment	Surrounding air temperature	-10°C to +50°C (non-freezing)
	Ambient humidity	90%RH or less (non-condensing)
	Storage temperature	-20°C to +65°C *1
	Atmosphere	Indoors (free from corrosive gas, flammable gas, oil mist, dust and dirt)
	Altitude/vibration	Maximum 1,000m above sea level. 5.9m/s ² or less at 10 to 55Hz (directions of X, Y, Z axes)

*1 Temperature applicable for a short time, e.g. in transit.

(2) Wiring

⚠ CAUTION

- Do not install a power factor correction capacitor or surge suppressor/capacitor type filter on the inverter output side. These devices on the inverter output side may be overheated or burn out.
- The connection orientation of the output cables U, V, W to the motor affects the rotation direction of the motor.

(3) Trial run

⚠ CAUTION

- Before starting operation, each parameter must be confirmed and adjusted. A failure to do so may cause some machines to make unexpected motions.

(4) Usage

⚠ WARNING

- Any person must stay away from the equipment when the retry function is set as it will restart suddenly after trip.
- Since pressing  key may not stop output depending on the function setting status, separate circuit and switch that make an emergency stop (power OFF, mechanical brake operation for emergency stop, etc.) must be provided.
- OFF status of the start signal must be confirmed before resetting the inverter fault. Resetting inverter alarm with the start signal ON restarts the motor suddenly.
- The inverter must be used for three-phase induction motors. Connection of any other electrical equipment to the inverter output may damage the equipment.
- Do not modify the equipment.
- Do not perform parts removal which is not instructed in this manual. Doing so may lead to fault or damage of the product.

⚠ CAUTION

- The electronic thermal relay function does not guarantee protection of the motor from overheating. It is recommended to install both an external thermal and PTC thermistor for overheat protection.
- Do not use a magnetic contactor on the inverter input for frequent starting/stopping of the inverter. Otherwise the life of the inverter decreases.
- The effect of electromagnetic interference must be reduced by using a noise filter or by other means. Otherwise nearby electronic equipment may be affected.
- Appropriate measures must be taken to suppress harmonics. Otherwise power supply harmonics from the inverter may heat/damage the power factor correction capacitor and generator.
- When driving a 400V class motor by the inverter, the motor must be an insulation-enhanced motor or measures must be taken to suppress surge voltage. Surge voltage attributable to the wiring constants may occur at the motor terminals, deteriorating the insulation of the motor.
- When parameter clear or all parameter clear is performed, the required parameters must be set again before starting operations because all parameters return to the initial value.
- The inverter can be easily set for high-speed operation. Before changing its setting, the performances of the motor and machine must be fully examined.
- Stop status cannot be hold by the inverter's brake function. In addition to the inverter's brake function, a holding device must be installed to ensure safety.
- Before running an inverter which had been stored for a long period, inspection and test operation must be performed.
- For prevention of damage due to static electricity, nearby metal must be touched before touching this product to eliminate static electricity from your body.

(5) Emergency stop

⚠ CAUTION

- A safety backup such as an emergency brake must be provided to prevent hazardous condition to the machine and equipment in case of inverter failure.
- When the breaker on the inverter input side trips, the inverter must be checked for fault (short circuit), and internal parts of the inverter for a damage, etc. The cause of the trip must be identified and removed before turning ON the power of the breaker.
- When any protective function is activated, appropriate corrective action must be taken, and the inverter must be reset before resuming operation.

(6) Maintenance, inspection and parts replacement

⚠ CAUTION

- Do not carry out a megger (insulation resistance) test on the control circuit of the inverter. It will cause a failure.

(7) Disposal

⚠ CAUTION

- The inverter must be treated as industrial waste.

General instruction

Many of the diagrams and drawings in this Instruction Manual (Basic) show the inverter without a cover or partially open for explanation. Never operate the inverter in this manner. The cover must be always reinstalled and the instruction in this Instruction Manual (Basic) must be followed when operating the inverter.

<Abbreviation>

- PU: Operation panel and parameter unit (FR-PU04, FR-PU07)
- Inverter: Mitsubishi inverter FR-E700 series safety stop function model
- FR-E700: Mitsubishi inverter FR-E700 series safety stop function model
- Pr.: Parameter number (Number assigned to function)
- PU operation: Operation using the PU (operation panel/FR-PU04/FR-PU07)
- External operation: Operation using the control circuit signals
- Combined operation : Operation using the PU (FR-PU04/FR-PU07) and external operation
- Standard motor : SF-JR
- Constant torque motor : SF-HRCA

<Trademark>

- LONWORKS® is a registered trademark of Echelon Corporation in the U.S.A and other countries.
- Company and product names herein are the trademarks and registered trademarks of their respective owners.

<Mark>



REMARKS: Additional helpful contents and relations with other functions are written.



Note: Contents requiring caution or cases when set functions are not activated are written.



POINT: Useful contents and points are written.

<Related document>



Refer to the *Instruction Manual (Applied)* for further information on the following points.

- Removal and reinstallation of the cover
- Connection of stand-alone option unit
- EMC and leakage currents
- Detailed explanation on parameters
- Troubleshooting
- Check first when you have a trouble
- Inspection items (life diagnosis, cooling fan replacement)
- Measurement of main circuit voltages, currents and powers
- For customers who are replacing the conventional model with this inverter

1 OUTLINE

1.1 Product checking and parts identification

Unpack the inverter and check the capacity plate on the front cover and the rating plate on the inverter side face to ensure that the product agrees with your order and the inverter is intact.

● Inverter model

FR - E740 - 3.7 K SC

No.	Voltage class
E720	Three-phase 200V class
E740	Three-phase 400V class
E720S	Single-phase 200V class

Represents the inverter capacity [kW]

Symbol	Control circuit terminal specification
SC	Safety stop function model

Cooling fan
The cooling fan is removable.

Operation panel
(Refer to page 2)

PU connector
(Refer to page 9)

Voltage/current input switch
(Refer to page 9)

USB connector cover
Refer to the Instruction Manual (Applied) for how to open the cover.

Front cover
Refer to the Instruction Manual (Applied) for installation/removal.

PU connector cover
Refer to the Instruction Manual (Applied) for how to open the cover.

Control logic switchover jumper connector

The jumper connector is in the sink logic (SINK) when shipped from the factory. Move the jumper connector to change to the source logic (SOURCE). Always fit the jumper connector to the either position.
(Refer to the Instruction Manual (Applied))

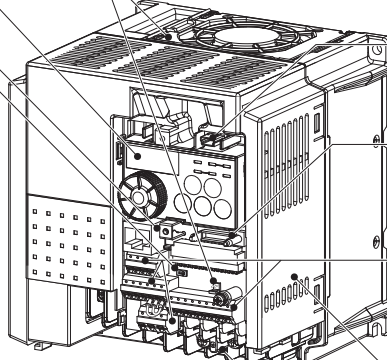
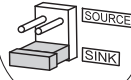

USB connector (mini-B connector)
(Refer to page 9)

Connector for plug-in option connection
(Refer to the instruction manual of options.)

Control circuit terminal block
(Refer to page 10)

Main circuit terminal block
(Refer to page 10)

Combed shaped wiring cover
Refer to the Instruction Manual (Applied) for installation/removal.

Example of FR-E740-3.7KSC

Capacity plate

FR-E740-3.7KSC ← Inverter model
SERIAL: XXXXXX ← Serial number

Rating plate

MITSUBISHI INVERTER
Inverter model → MODEL FR-E740-3.7KSC
Input rating → INPUT : XXXXX
Output rating → OUTPUT : XXXXX
Serial number → SERIAL : _____

MITSUBISHI ELECTRIC CORPORATION
MADE IN JAPAN

PASSED

● Accessory

- Fan cover fixing screws (M3 × 35mm)

These screws are necessary for compliance with the EU Directive (Refer to page 49)

Capacity	Quantity
FR-E720-1.5KSC to 3.7KSC, FR-E740-1.5KSC to 3.7KSC, FR-E720S-0.75KSC to 2.2KSC	1
FR-E720-5.5KSC to 15KSC, FR-E740-5.5KSC to 15KSC	2

Harmonic suppression guideline (when inverters are used in Japan)

All models of general-purpose inverters used by specific consumers are covered by "Harmonic suppression guideline for consumers who receive high voltage or special high voltage". (For further details, refer to Chapter 3 of the Instruction Manual (Applied).)

1.2 Operation panel

1.2.1 Names and functions of the operation panel

The operation panel cannot be removed from the inverter.

Operation mode indicator
 PU: Lit to indicate PU operation mode.
 EXT: Lit to indicate External operation mode.
 (Lit at power-ON at initial setting.)
 NET: Lit to indicate Network operation mode.
 PU, EXT: Lit to indicate External/PU combined operation mode 1, 2.
 These turn OFF when command source is not on operation panel.

Unit indicator
 Hz: Lit to indicate frequency.
 (Flickers when the set frequency monitor is displayed.)
 A: Lit to indicate current.
 (Both "Hz" and "A" turn OFF when other than the above is displayed.)

Monitor (4-digit LED)
 Shows the frequency, parameter number, etc.

Setting dial
 (Setting dial: Mitsubishi inverter dial)
 Used to change the frequency setting and parameter settings.
 Press to display the following.
 • Displays the set frequency in the monitor mode
 • Present set value is displayed during calibration
 • Displays the order in the faults history mode

Mode switchover
 Used to change each setting mode.
 Pressing **PU/EXT** simultaneously changes the operation mode.
 Pressing for a while (2s) can lock operation. (Refer to the Instruction Manual (Applied))

Determination of each setting
 If pressed during operation, monitor changes as below:

```

    graph TD
      A[Running frequency] --> B[Output current]
      B --> C[Output voltage]
      C --> A
    
```

Operating status indicator
 Lit or flicker during inverter operation. *
 * Lit: When the forward rotation operation is being performed.
 Slow flickering (1.4s cycle):
 When the reverse operation is being performed.
 Fast flickering (0.2s cycle):
 When **RUN** was pressed or the start command was given, but the operation cannot be made.
 •When the frequency command is less than the starting frequency.
 •When the MRS signal is input.

Parameter setting mode
 Lit to indicate parameter setting mode.

Monitor indicator
 Lit to indicate monitoring mode.

Stop operation
 Used to stop Run command.
 Fault can be reset when protective function is activated (fault).

Operation mode switchover
 Used to switch between the PU and External operation mode.
 When using the External operation mode (operation using a separately connected frequency setting potentiometer and start signal), press this key to light up the EXT indication.
 (Press **MODE** simultaneously (0.5s) or change Pr. 79 setting to change to combined mode.) (Refer to the Instruction Manual (Applied))
 PU: PU operation mode
 EXT: External operation mode
 Cancels PU stop also.

Start command
 The rotation direction can be selected by setting Pr. 40.

1.2.2 Basic operation (factory setting)

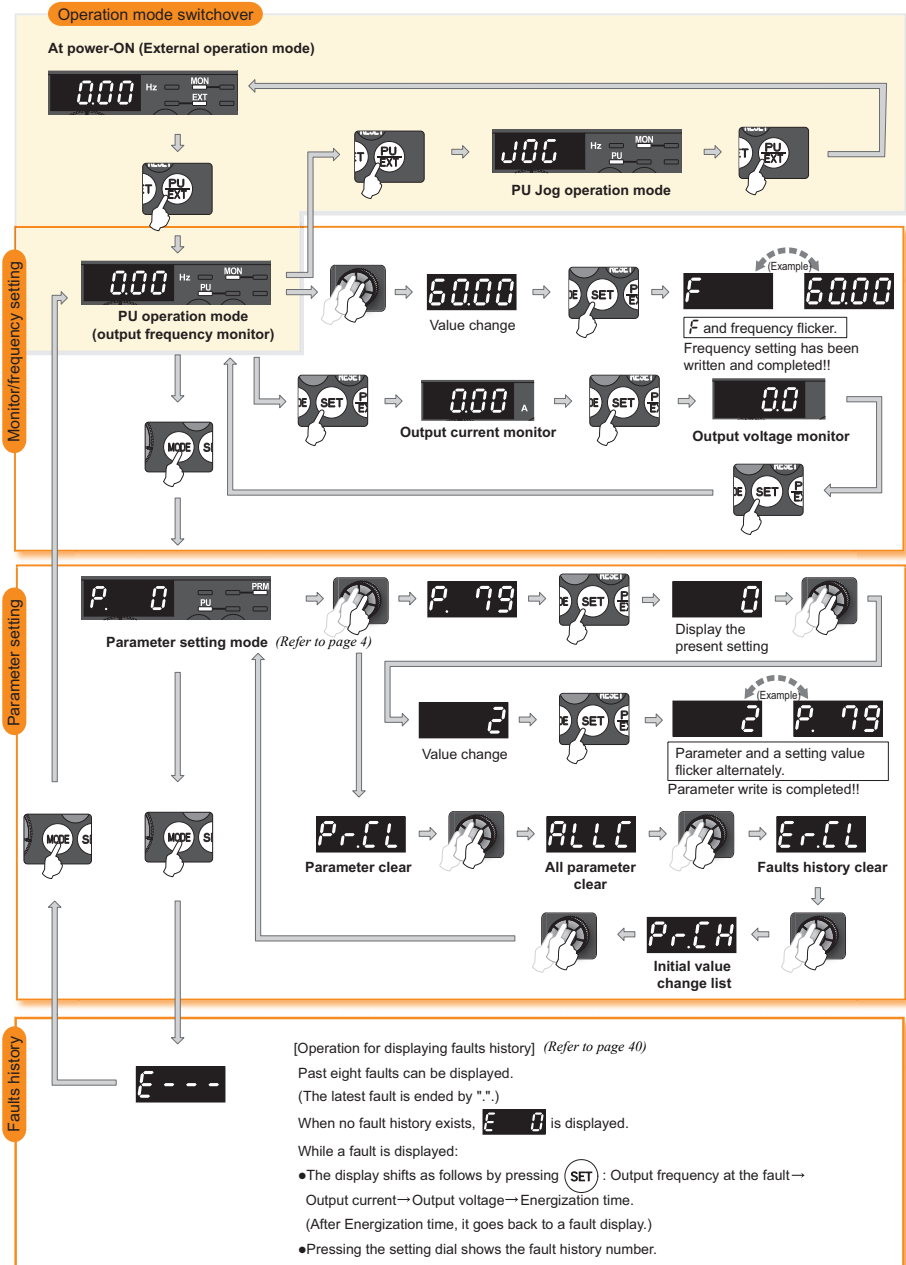

1

1.2.3 Changing the parameter setting value

Changing example

Change the Pr. 1 Maximum frequency setting.

Operation	Display
1. Screen at power-ON The monitor display appears.	
2. Press PU/EXT to choose the PU operation mode.	PU indicator is lit.
3. Press MODE to choose the parameter setting mode.	PRM indicator is lit.
4. Turn ▲/▼ until P. 1 appears.	
5. Press SET to read the currently set value. "120.0"(120.0Hz (initial value)) appears.	
6. Turn ▲/▼ to change the set value to "60.00" (60.00Hz).	
7. Press SET to set.	

Flicker...Parameter setting complete!!

- Turn **▲/▼** to read another parameter.
- Press **SET** to show the setting again.
- Press **SET** twice to show the next parameter.
- Press **MODE** twice to return the monitor to frequency monitor.

REMARKS

? **Er 1** to **Er 4** is displayed...Why?

- Er 1** appearsWrite disable error
- Er 2** appearsWrite error during operation
- Er 3** appearsCalibration error
- Er 4** appearsMode designation error

(For details, Refer to the Instruction Manual (Applied).)

- The number of digits displayed on the operation panel is four. Only the upper four digits of values can be displayed and set. If the values to be displayed have five digits or more including decimal places, the fifth or later numerals can not be displayed nor set. (Example) For Pr. 1
When 60Hz is set, 60.00 is displayed.
When 120Hz is set, 120.0 is displayed and second decimal place is not displayed nor set.

1.2.4 Parameter clear/all parameter clear





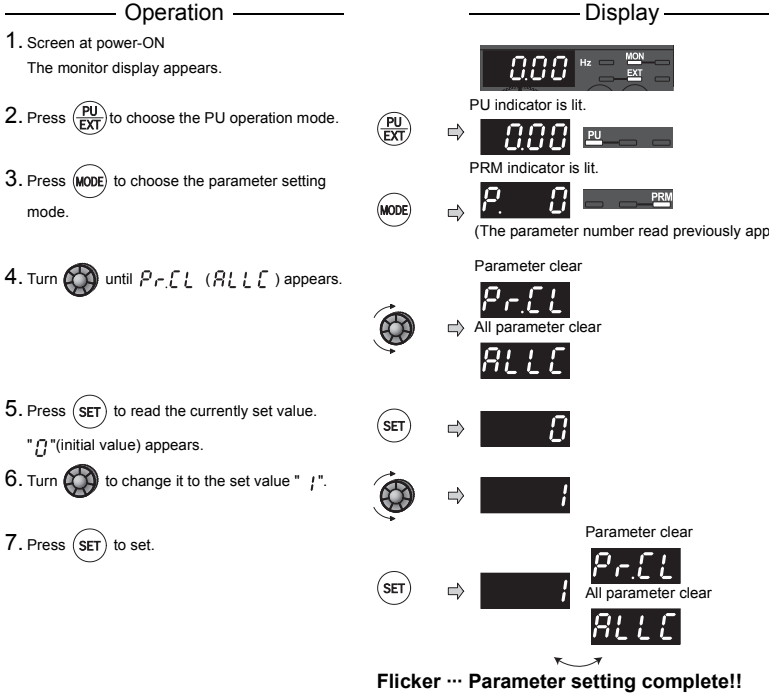

POINT

- Set "1" in *Pr.CL* Parameter clear, *ALLC* all parameter clear to initialize all parameters. (Parameters are not cleared when "1" is set in *Pr.77* Parameter write selection.)
- Refer to the extended parameter list of  the Instruction Manual (Applied) for parameters cleared with this operation.







Flicker ... Parameter setting complete!!

- Turn  to read another parameter.
- Press  to show the setting again.
- Press  twice to show the next parameter.

Setting	Description
0	Not executed.
1	Sets parameters back to the initial values. (Parameter clear sets back all parameters except <i>calibration parameters</i> and <i>terminal function selection parameters</i> to the initial values.) Refer to the parameter list of  the Instruction Manual (Applied) for availability of parameter clear and all parameter clear.



REMARKS

- ?  1 and *E_r 4* are displayed alternately ... Why?
-  The inverter is not in the PU operation mode.
 -  PU connector or USB connector is used.
- Press . [PU] is lit and the monitor (4-digit LED) displays "1". (When *Pr.79* = "0" (initial value))
 - Carry out operation from step 6 again.

2 INSTALLATION AND WIRING

AC power supply

Use within the permissible power supply specifications of the inverter. To ensure safety, use a moulded case circuit breaker, earth leakage circuit breaker or magnetic contactor to switch power ON/OFF. (Refer to page 46)

Moulded case circuit breaker (MCCB) or earth leakage circuit breaker (ELB), fuse

The breaker must be selected carefully since an in-rush current flows in the inverter at power ON. (Refer to page 7)

Magnetic contactor (MC)

Install the magnetic contactor to ensure safety. Do not use this magnetic contactor to start and stop the inverter. Doing so will cause the inverter life to be shorten. (Refer to page 7)

Reactor (FR-HAL, FR-HEL option)

Reactors (option) must be used when power harmonics measures are taken, the power factor is to be improved or the inverter is installed near a large power supply system (500kVA or more). The inverter may be damaged if you do not use reactors. Select the reactor according to the model. Remove the jumpers across terminals P/+ and P1 to connect the DC reactor.

AC reactor (FR-HAL)

DC reactor (FR-HEL) *

EMC filter (ferrite core) * (FR-BSF01, FR-BLF)

Install an EMC filter (ferrite core) to reduce the electromagnetic noise generated from the inverter. Effective in the range from about 1MHz to 10MHz. When more wires are passed through, a more effective result can be obtained. A wire should be wound four turns or more.

EMC filter (capacitor) * (FR-BIF)

Reduces the radio noise.

Inverter (FR-E700)

R/L1 S/L2 T/L3

Earth (Ground)

P/+ N/-

EMC filter (ferrite core) (FR-BSF01, FR-BLF)

Install an EMC filter (ferrite core) to reduce the electromagnetic noise generated from the inverter. Effective in the range from about 1MHz to 10MHz. A wire should be wound four turns at a maximum.

Motor

Devices connected to the output

Do not install a power factor correction capacitor, surge suppressor or capacitor type filter on the output side of the inverter. When installing a moulded case circuit breaker on the output side of the inverter, contact each manufacturer for selection of the moulded case circuit breaker.

Earth (Ground)

To prevent an electric shock, always earth (ground) the motor and inverter. For reduction of induction noise from the power line of the inverter, it is recommended to wire the earthing cable by returning it to the earth (ground) terminal of the inverter.

NOTE

- The life of the inverter is influenced by surrounding air temperature. The surrounding air temperature should be as low as possible within the permissible range. This must be noted especially when the inverter is installed in an enclosure. (Refer to page 8)
- Wrong wiring might lead to damage of the inverter. The control signal lines must be kept fully away from the main circuit to protect them from noise. (Refer to page 9)
- Do not install a power factor correction capacitor, surge suppressor or capacitor type filter on the inverter output side. This will cause the inverter to trip or the capacitor and surge suppressor to be damaged. If any of the above devices are connected, immediately remove them.
- Electromagnetic wave interference
 - The input/output (main circuit) of the inverter includes high frequency components, which may interfere with the communication devices (such as AM radios) used near the inverter. In this case, install options among the capacitor type EMC filter FR-BIF (for use in the input side only), the ferrite core type EMC filter FR-BSF01/FR-BLF, filterpack, and EMC filter to minimize the interference. (Refer to Chapter 3 of the Instruction Manual (Applied)).
 - Refer to the instruction manual of each option and peripheral devices for details of peripheral devices.

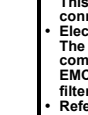
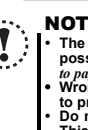
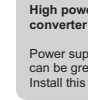

Parameter unit (FR-PU07)



Enclosure surface operation panel (FR-PA07)

By connecting the connection cable (FR-CB2) to the PU connector, operation can be performed from FR-PU07, FR-PA07.

USB connector

A personal computer and an inverter can be connected with a USB (Ver1. 1) cable.

(Refer to Chapter 4 of the Instruction Manual (Applied))



S1
S2
SC

Approved safety relay module
Required for compliance with safety standard.

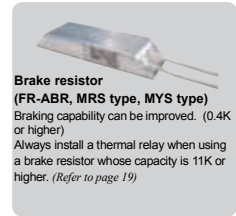

Brake resistor (FR-ABR, MRS type, MYS type)

Braking capability can be improved. (0.4K or higher)
Always install a thermal relay when using a brake resistor whose capacity is 11K or higher. (Refer to page 19)

P/+

PR

U V W

Earth (Ground)

P/+ N/-

Earth (Ground)

Earth (Ground)

Earth (Ground)

Earth (Ground)

Earth (Ground)

Earth (Ground)

Earth (Ground)

Earth (Ground)

Earth (Ground)

Earth (Ground)

Earth (Ground)

Earth (Ground)

Earth (Ground)

Earth (Ground)

Earth (Ground)

Earth (Ground)

Earth (Ground)

2.1 Peripheral devices

Check the inverter model of the inverter you purchased. Appropriate peripheral devices must be selected according to the capacity. Refer to the following list and prepare appropriate peripheral devices.

Applicable Inverter Model	Motor Output (kW)	Moulded Case Circuit Breaker (MCCB) *1 or Earth Leakage Circuit Breaker (ELB) *2		Magnetic Contactor (MC) *3		Reactor		
		Reactor connection		Reactor connection		FR-HAL	FR-HEL	
		without	with	without	with			
Three-Phase 200V	FR-E720-0.1KSC	0.1	5A	5A	S-N10	S-N10	0.4K *4	0.4K *4
	FR-E720-0.2KSC	0.2	5A	5A	S-N10	S-N10	0.4K *4	0.4K *4
	FR-E720-0.4KSC	0.4	5A	5A	S-N10	S-N10	0.4K	0.4K
	FR-E720-0.75KSC	0.75	10A	10A	S-N10	S-N10	0.75K	0.75K
	FR-E720-1.5KSC	1.5	15A	15A	S-N10	S-N10	1.5K	1.5K
	FR-E720-2.2KSC	2.2	20A	15A	S-N10	S-N10	2.2K	2.2K
	FR-E720-3.7KSC	3.7	30A	30A	S-N20, S-N21	S-N10	3.7K	3.7K
	FR-E720-5.5KSC	5.5	50A	40A	S-N25	S-N20, S-N21	5.5K	5.5K
	FR-E720-7.5KSC	7.5	60A	50A	S-N25	S-N25	7.5K	7.5K
	FR-E720-11KSC	11	75A	75A	S-N35	S-N35	11K	11K
FR-E720-15KSC	15	125A	100A	S-N50	S-N50	15K	15K	
Three-Phase 400V	FR-E740-0.4KSC	0.4	5A	5A	S-N10	S-N10	H0.4K	H0.4K
	FR-E740-0.75KSC	0.75	5A	5A	S-N10	S-N10	H0.75K	H0.75K
	FR-E740-1.5KSC	1.5	10A	10A	S-N10	S-N10	H1.5K	H1.5K
	FR-E740-2.2KSC	2.2	15A	10A	S-N10	S-N10	H2.2K	H2.2K
	FR-E740-3.7KSC	3.7	20A	15A	S-N10	S-N10	H3.7K	H3.7K
	FR-E740-5.5KSC	5.5	30A	20A	S-N20, S-N21	S-N11, S-N12	H5.5K	H5.5K
	FR-E740-7.5KSC	7.5	30A	30A	S-N20, S-N21	S-N20, S-N21	H7.5K	H7.5K
	FR-E740-11KSC	11	50A	40A	S-N20, S-N21	S-N20, S-N21	H11K	H11K
	FR-E740-15KSC	15	60A	50A	S-N25	S-N20, S-N21	H15K	H15K
Single-Phase 200V	FR-E720S-0.1KSC	0.1	5A	5A	S-N10	S-N10	0.4K *4	0.4K *4
	FR-E720S-0.2KSC	0.2	5A	5A	S-N10	S-N10	0.4K *4	0.4K *4
	FR-E720S-0.4KSC	0.4	10A	10A	S-N10	S-N10	0.75K *4	0.75K *4
	FR-E720S-0.75KSC	0.75	15A	10A	S-N10	S-N10	1.5K *4	1.5K *4
	FR-E720S-1.5KSC	1.5	20A	20A	S-N10	S-N10	2.2K *4	2.2K *4
	FR-E720S-2.2KSC	2.2	40A	30A	S-N20, S-N21	S-N10	3.7K *4	3.7K *4

- *1 Select an MCCB according to the power supply capacity.
• Install one MCCB per inverter.

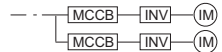

- *2 For the use in the United States or Canada, select a UL and cUL certified fuse with Class T fuse equivalent cut-off speed or faster with the appropriate rating for branch circuit protection. Alternatively, select a UL489 molded case circuit breaker (MCCB). (Refer to page 52)
- *3 Magnetic contactor is selected based on the AC-1 class. The electrical durability of magnetic contactor is 500,000 times. When the magnetic contactor is used for emergency stop during motor driving, the electrical durability is 25 times.
When using the MC for emergency stop during motor driving or using on the motor side during commercial-power supply operation, select the MC with class AC-3 rated current for the motor rated current.
- *4 The power factor may be slightly lower.



NOTE

- When the inverter capacity is larger than the motor capacity, select an MCCB and a magnetic contactor according to the inverter model and cable and reactor according to the motor output.
- When the breaker on the inverter input side trips, check for the wiring fault (short circuit), damage to internal parts of the inverter, etc. Identify the cause of the trip, then remove the cause and power ON the breaker.

2.2 Installation of the inverter and instructions

(1) Installation of the inverter

Enclosure surface mounting

Remove the front cover and wiring cover to fix the inverter to the surface. (Remove the covers in the directions of the arrows.)

- FR-E720-0.1KSC to 0.75KSC
- FR-E720S-0.1KSC to 0.4KSC

- FR-E720-1.5KSC to 3.7KSC
- FR-E740-0.4KSC to 7.5KSC
- FR-E720S-0.75KSC or higher

- FR-E720-5.5KSC to 15KSC
- FR-E740-11KSC, 15KSC

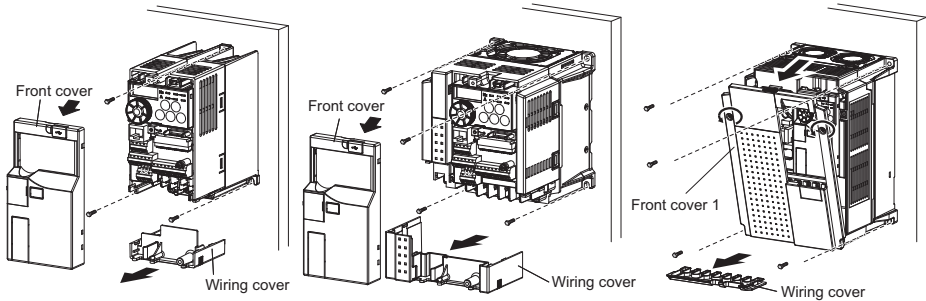

Note

- When encasing multiple inverters, install them in parallel as a cooling measure.
- Install the inverter vertically.
- For heat dissipation and maintenance, take at least the clearances shown in the table below from the inverter to the other devices and to the enclosure surface.

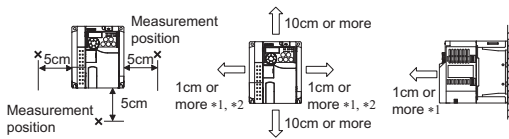

-10°C to +50°C
(non-freezing)

*1 Take 5cm or more clearances for 5.5K or higher.

*2 When using the inverters at the surrounding air temperature of 40°C or less, the inverters can be installed without any clearance between them (0cm clearance).

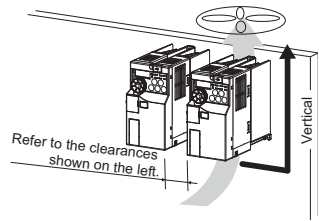

(2) Environment

Before installation, check that the environment meets the specifications on page 47.



Note

- Install the inverter on a strong surface securely and vertically with bolts.
- Leave enough clearances and take cooling measures.
- Avoid places where the inverter is subjected to direct sunlight, high temperature and high humidity.
- Install the inverter on a nonflammable wall surface.

2.3 Wiring

2.3.1 Terminal connection diagram

Sink logic

- ⊙ Main circuit terminal
- Control circuit terminal

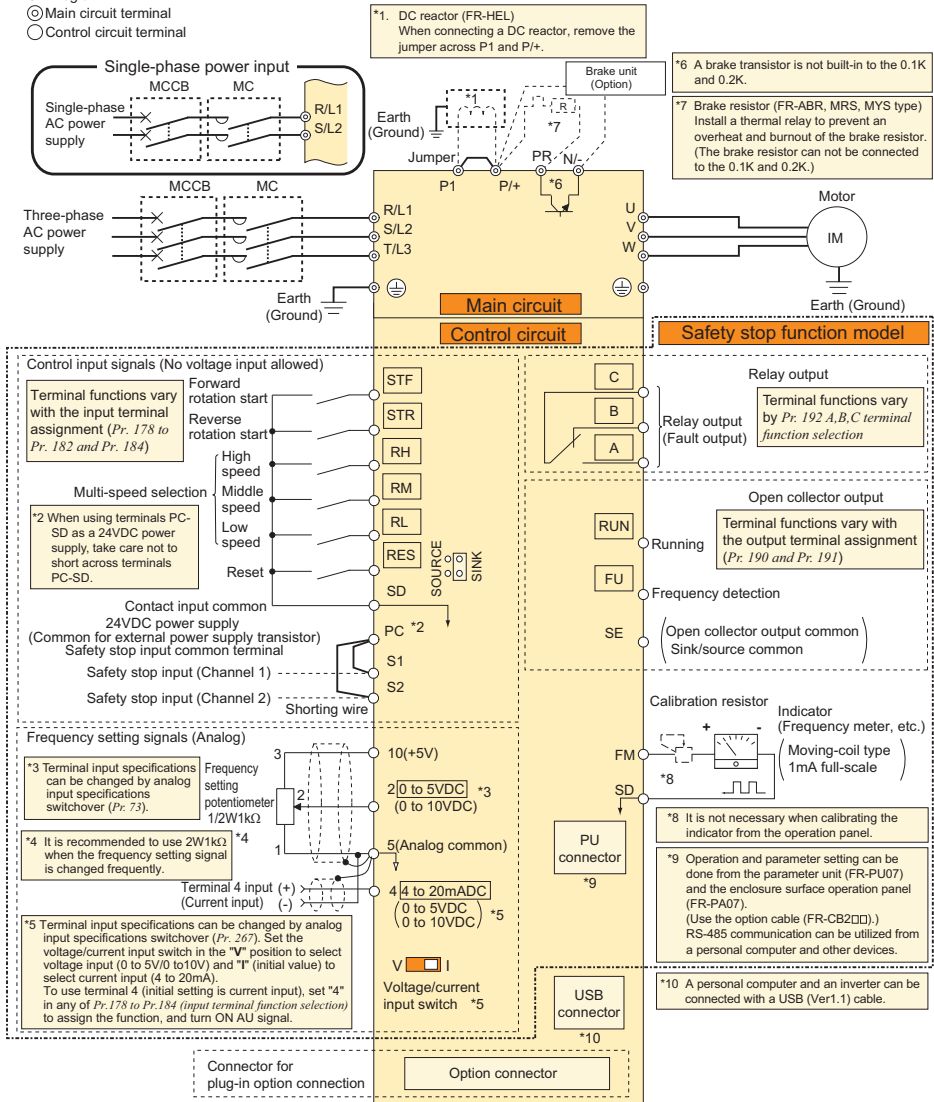

NOTE

- To prevent a malfunction caused by noise, separate the signal cables more than 10cm from the power cables. Also separate the main circuit wire of the input side and the output side.
- After wiring, wire cutoffs must not be left in the inverter. Wire cutoffs can cause an alarm, failure or malfunction. Always keep the inverter clean. When drilling mounting holes in an enclosure etc., take care not to allow chips and other foreign matter to enter the inverter.
- The output of the single-phase power input model is three-phase 200V.

2.3.2 Terminal specifications

Type	Terminal Symbol	Terminal Name	Description		
Main circuit	R/L1, S/L2, T/L3 *	AC power input	Connect to the commercial power supply. Keep these terminals open when using the high power factor converter (FR-HC) or power regeneration common converter (FR-CV). * When using single-phase power input, terminals are R/L1 and S/L2.		
	U, V, W	Inverter output	Connect a three-phase squirrel-cage motor.		
	P/+, PR	Brake resistor connection	Connect a brake resistor (MRS type, MYS type, FR-ABR) across terminals P/+ and PR. (The brake resistor can not be connected to the 0.1K or 0.2K)		
	P/+, N/-	Brake unit connection	Connect the brake unit (FR-BU2), power regeneration common converter (FR-CV) or high power factor converter (FR-HC).		
		DC power input	Connect the plus side of the power supply to terminal P/+ and minus side to terminal N/-.		
	P/+, P1	DC reactor connection	Remove the jumper across terminals P/+ and P1 and connect a DC reactor.		
		Earth (Ground)	For earthing (grounding) the inverter chassis. Must be earthed (grounded).		
Control circuit/input signal	Contact input	STF	Forward rotation start	Turn ON the STF signal to start forward rotation and turn it OFF to stop.	When the STF and STR signals are turned ON simultaneously, the stop command is given.
		STR	Reverse rotation start	Turn ON the STR signal to start reverse rotation and turn it OFF to stop.	
		RH, RM, RL	Multi-speed selection	Multi-speed can be selected according to the combination of RH, RM and RL signals.	
		RES	Reset	Used to reset alarm output provided when protective circuit is activated. Turn ON the RES signal for more than 0.1s, then turn it OFF. Initial setting is for reset always. By setting Pr. 75, reset can be set to enabled only at fault occurrence. Recover about 1s after reset is cancelled.	
	PC	SD	Contact input common (sink) (initial setting)	Common terminal for contact input terminal (sink logic) and terminal FM.	
			External transistor common (source)	Connect this terminal to the power supply common terminal of a transistor output (open collector output) device, such as a programmable controller, in the source logic to avoid malfunction by undesirable current.	
			24VDC power supply common	Common output terminal for 24VDC 0.1A power supply (PC terminal). Isolated from terminals 5 and SE.	
		Safety stop input terminal common	External transistor common (sink) (initial setting)	Connect this terminal to the power supply common terminal of a transistor output (open collector output) device, such as a programmable controller, in the sink logic to avoid malfunction by undesirable current.	
			Contact input common (source)	Common terminal for contact input terminal (source logic).	
			24VDC power supply	Can be used as 24VDC 0.1A power supply.	
	Safety stop function *	S1	Safety stop input (Channel 1)	S1/S2 are safety stop signals for use with in conjunction with an approved external safety unit. Both S1/S2 must be used in dual channel form. Inverter output is shutoff depending on shorting/opening between S1 and PC, S2 and PC.	Input resistance 4.7kΩ Voltage when contacts are open 21 to 26VDC When contacts are short-circuited 4 to 6mADC
		S2	Safety stop input (Channel 2)	In the initial status, terminal S1 and S2 are shorted with terminal PC by shorting wire. Remove the shorting wire and connect the safety relay module when using the safety stop function.	

* For more details, refer to the Safety stop function instruction manual (BCN-A211508-004). (Refer to the front cover for how to obtain the manual.)

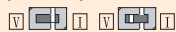
Type	Terminal Symbol	Terminal Name	Description	
Control circuit/input signal	Frequency setting	10	Frequency setting power supply Used as power supply when connecting potentiometer for frequency setting (speed setting) from outside of the inverter. 5VDC permissible load current 10mA	
		2	Frequency setting (voltage) Inputting 0 to 5VDC (or 0 to 10V) provides the maximum output frequency at 5V (10V) and makes input and output proportional. Use Pr. 73 to switch between input 0 to 5VDC (initial setting) and 0 to 10VDC input. Input resistance 10kΩ ± 1kΩ Permissible maximum voltage 20VDC	
		4	Frequency setting (current) Inputting 0 to 20mADC (or 0 to 5V / 0 to 10V) provides the maximum output frequency at 20mA and makes input and output proportional. This input signal is valid only when the AU signal is ON (terminal 2 input is invalid). To use terminal 4 (initial setting is current input), set "4" to any of Pr.178 to Pr.184 (input terminal function selection), and turn AU signal ON. Use Pr. 267 to switch among input 4 to 20mA (initial setting), 0 to 5VDC, and 0 to 10VDC. Set the voltage/current input switch in the "V" position to select voltage input (0 to 5V/0 to 10V). Current input (initial status) Voltage input 	Voltage input: Input resistance 10kΩ ± 1kΩ Permissible maximum voltage 20VDC Current input: Input resistance 233Ω ± 5Ω Maximum permissible current 30mA.
		5	Frequency setting common Common terminal for the frequency setting signals (terminals 2 and 4). Do not earth (ground).	
		Relay	A, B, C	Relay output (fault output) 1 changeover contact output indicates that the inverter fault occurs. Fault: discontinuity across B and C (continuity across A and C), Normal: continuity across B and C (discontinuity across A and C) Contact capacity 230VAC 0.3A (power factor = 0.4) 30VDC 0.3A
Control circuit/output signal	Open collector	RUN	Inverter running Switched Low when the inverter output frequency is equal to or higher than the starting frequency (initial value 0.5Hz). Switched High during stop or DC injection brake operation.* Permissible load 24VDC (Maximum 27VDC) 0.1A (a voltage drop is 3.4V maximum when the signal is ON)	
		FU	Frequency detection Switched Low when the inverter output frequency is equal to or higher than the preset detected frequency and High when less than the preset detected frequency.* * Low is when the open collector output transistor is ON (conducts). High is when the transistor is OFF (does not conduct).	
		SE	Open collector output common Common terminal of terminal RUN and FU.	
Communication	Pulse	FM	For meter Used to output a selected monitored item (such as Output frequency) among several monitored items. (Not output during inverter reset.) The output signal is proportional to the magnitude of the corresponding monitoring item. Permissible load current 1mA 1440 pulses/s at 60Hz	
		—	PU connector With the PU connector, RS-485 communication can be established. · Conforming standard: EIA-485 (RS-485) · Transmission format: Multi-drop link · Communication speed: 4800 to 38400bps · Overall extension: 500m	
—	USB connector A personal computer and an inverter can be connected with a USB (Ver1.1) cable. · Interface: conforms to USB1.1 · Transmission Speed: 12Mbps · Connector: USB mini B connector (receptacle mini B type)			



Note

- Set Pr. 267 and a voltage/current input switch correctly, then input an analog signal in accordance with the setting. Applying a voltage with voltage/current input switch in "I" position (current input is selected) or a current with switch in "V" position (voltage input is selected) could cause component damage of the inverter or analog circuit of output devices.
- The inverter will be damaged if power is applied to the inverter output terminals (U, V, W). Never perform such wiring.
-  indicates that terminal functions can be selected using Pr. 178 to Pr. 182, Pr. 184 and Pr. 190 to Pr. 192 (I/O terminal function selection).
- Terminal names and terminal functions are those of the factory set.
- When connecting the DC power supply, be sure to connect the plus side of the power supply to terminal P+ and minus side to terminal N/-. Opposite polarity will damage the inverter.

2.3.3 Terminal arrangement of the main circuit terminal, power supply and the motor wiring

Three-phase 200V/400V class

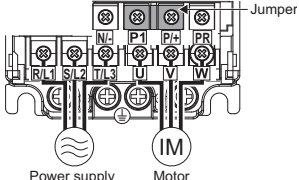
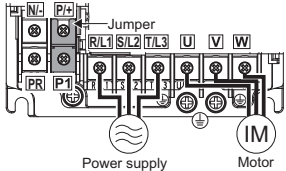
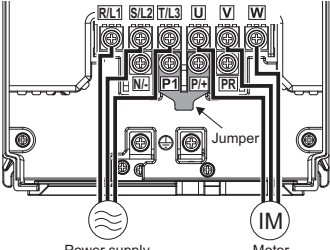
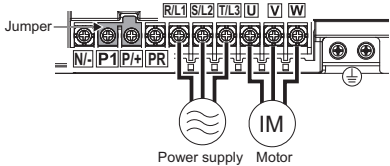
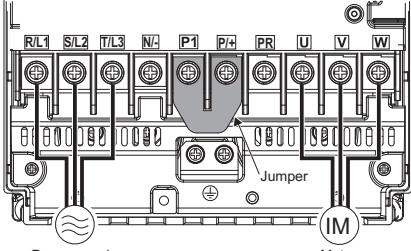
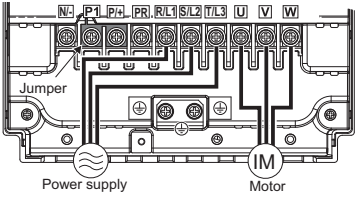
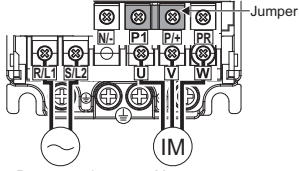
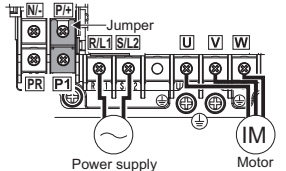
<p>FR-E720-0.1KSC to 0.75KSC</p>  <p>Power supply Motor</p>	<p>FR-E720-1.5KSC to 3.7KSC FR-E740-0.4KSC to 3.7KSC</p>  <p>Power supply Motor</p>
<p>FR-E720-5.5KSC, 7.5KSC</p>  <p>Power supply Motor</p>	<p>FR-E740-5.5KSC, 7.5KSC</p>  <p>Power supply Motor</p>
<p>FR-E720-11KSC, 15KSC</p>  <p>Power supply Motor</p>	<p>FR-E740-11KSC, 15KSC</p>  <p>Power supply Motor</p>
<h4>Single-phase 200V class</h4>	
<p>FR-E720S-0.1KSC to 0.4KSC</p>  <p>Power supply Motor</p>	<p>FR-E720S-0.75KSC to 2.2KSC</p>  <p>Power supply Motor</p>



NOTE

- Make sure the power cables are connected to the R/L1, S/L2, and T/L3. (Phase need not be matched.) Never connect the power cables to the U, V, and W of the inverter. Doing so will damage the inverter.
- Connect the motor to U, V, and W. Turning ON the forward rotation switch (signal) at this time rotates the motor counterclockwise when viewed from the load shaft.

(1) Cable size and other specifications of the main circuit terminals and the earthing terminal

Select the recommended cable size to ensure that a voltage drop will be 2% or less.

If the wiring distance is long between the inverter and motor, a main circuit cable voltage drop will cause the motor torque to decrease especially at the output of a low frequency.

The following table indicates a selection example for the wiring length of 20m.

Three-phase 200V class (when input power supply is 220V)

Applicable Inverter Model	Terminal Screw Size ⁺⁴	Tightening Torque N·m	Crimping Terminal		Cable Size								
					HIV Cables, etc. (mm ²) ⁺¹			AWG ⁺²		PVC Cables, etc. (mm ²) ⁺³			
					R/L1 S/L2 T/L3	U, V, W	R/L1 S/L2 T/L3	U, V, W	Earthing cable	R/L1 S/L2 T/L3	U, V, W	R/L1 S/L2 T/L3	U, V, W
FR-E720-0.1KSC to 0.75KSC	M3.5	1.2	2-3.5	2-3.5	2	2	2	14	14	2.5	2.5	2.5	
FR-E720-1.5KSC, 2.2KSC	M4	1.5	2-4	2-4	2	2	2	14	14	2.5	2.5	2.5	
FR-E720-3.7KSC	M4	1.5	5.5-4	5.5-4	3.5	3.5	3.5	12	12	4	4	4	
FR-E720-5.5KSC	M5	2.5	5.5-5	5.5-5	5.5	5.5	5.5	10	10	6	6	6	
FR-E720-7.5KSC	M5	2.5	14-5	8-5	14	8	5.5	6	8	16	10	6	
FR-E720-11KSC	M5	2.5	14-5	14-5	14	14	14	6	6	16	16	16	
FR-E720-15KSC	M6(M5)	4.4	22-6	22-6	22	22	14	4	4	25	25	16	

Three-phase 400V class (when input power supply is 440V)

Applicable Inverter Model	Terminal Screw Size ⁺⁴	Tightening Torque N·m	Crimping Terminal		Cable Size								
					HIV Cables, etc. (mm ²) ⁺¹			AWG ⁺²		PVC Cables, etc. (mm ²) ⁺³			
					R/L1 S/L2 T/L3	U, V, W	R/L1 S/L2 T/L3	U, V, W	Earthing cable	R/L1 S/L2 T/L3	U, V, W	R/L1 S/L2 T/L3	U, V, W
FR-E740-0.4KSC to 3.7KSC	M4	1.5	2-4	2-4	2	2	2	14	14	2.5	2.5	2.5	
FR-E740-5.5KSC	M4	1.5	5.5-4	2-4	3.5	2	3.5	12	14	4	2.5	4	
FR-E740-7.5KSC	M4	1.5	5.5-4	5.5-4	3.5	3.5	3.5	12	12	4	4	4	
FR-E740-11KSC	M4	1.5	5.5-4	5.5-4	5.5	5.5	8	10	10	6	6	10	
FR-E740-15KSC	M5	2.5	8-5	8-5	8	8	8	8	8	10	10	10	

Single-phase 200V class (when input power supply is 220V)

Applicable Inverter Model	Terminal Screw Size ⁺⁴	Tightening Torque N·m	Crimping Terminal		Cable Size								
					HIV Cables, etc. (mm ²) ⁺¹			AWG ⁺²		PVC Cables, etc. (mm ²) ⁺³			
					R/L1 S/L2	U, V, W	R/L1 S/L2	U, V, W	Earthing cable	R/L1 S/L2	U, V, W	R/L1 S/L2	U, V, W
FR-E720S-0.1KSC to 0.4KSC	M3.5	1.2	2-3.5	2-3.5	2	2	2	14	14	2.5	2.5	2.5	
FR-E720S-0.75KSC	M4	1.5	2-4	2-4	2	2	2	14	14	2.5	2.5	2.5	
FR-E720S-1.5KSC	M4	1.5	2-4	2-4	2	2	2	14	14	2.5	2.5	2.5	
FR-E720S-2.2KSC	M4	1.5	5.5-4	2-4	3.5	2	2	12	14	4	2.5	2.5	

*1 The cable size is that of the cable (HIV cable (600V class 2 vinyl-insulated cable) etc.) with continuous maximum permissible temperature of 75°C. Assumes that the surrounding air temperature is 50°C or less and the wiring distance is 20m or less.

*2 The recommended cable size is that of the cable (THHW cable) with continuous maximum permissible temperature of 75°C. Assumes that the surrounding air temperature is 40°C or less and the wiring distance is 20m or less. (Selection example for use mainly in the United States.)

*3 The recommended cable size is that of the cable (PVC cable) with continuous maximum permissible temperature of 70°C. Assumes that the surrounding air temperature is 40°C or less and the wiring distance is 20m or less. (Selection example for use mainly in Europe.)

*4 The terminal screw size indicates the terminal size for R/L1, S/L2, T/L3, U, V, W, and a screw for earthing (grounding).

A screw for earthing (grounding) of the FR-E720-15KSC is indicated in ().

For single-phase power input, the terminal screw size indicates the size of terminal screw for R/L1, S/L2, U, V, W, PR, P/+, N-, P1 and a screw for earthing (grounding).

**NOTE**

- Tighten the terminal screw to the specified torque. A screw that has been tightened too loosely can cause a short circuit or malfunction. A screw that has been tightened too tightly can cause a short circuit or malfunction due to the unit breakage.
- Use crimping terminals with insulation sleeve to wire the power supply and motor.

The line voltage drop can be calculated by the following formula:

$$\text{Line voltage drop [V]} = \frac{\sqrt{3} \times \text{wire resistance [m}\Omega\text{/m]} \times \text{wiring distance [m]} \times \text{current [A]}}{1000}$$

Use a larger diameter cable when the wiring distance is long or when it is desired to decrease the voltage drop (torque reduction) in the low speed range.

(2) Total wiring length

The overall wiring length for connection of a single motor or multiple motors should be within the value in the table below.

<i>Pr. 72 PWM frequency selection Setting (carrier frequency)</i>		0.1K	0.2K	0.4K	0.75K	1.5K	2.2K	3.7K or More
1 (1kHz) or less	200V class	200m	200m	300m	500m	500m	500m	500m
	400V class	-	-	200m	200m	300m	500m	500m
2 to 15 (2kHz to 14.5kHz)	200V class	30m	100m	200m	300m	500m	500m	500m
	400V class	-	-	30m	100m	200m	300m	500m

When driving a 400V class motor by the inverter, surge voltages attributable to the wiring constants may occur at the motor terminals, deteriorating the insulation of the motor. Take the following measures 1) or 2) in this case.



- 1) Use a "400V class inverter-driven insulation-enhanced motor" and set frequency in *Pr. 72 PWM frequency selection* according to wiring length.

	Wiring Length		
	50m or less	50m to 100m	Exceeding 100m
Carrier frequency	14.5kHz or less	8kHz or less	2kHz or less

- 2) Connect the surge voltage suppression filter (FR-ASF-H/FR-BMF-H) on the inverter output side.

NOTE



- Especially for long-distance wiring, the inverter may be affected by a charging current caused by the stray capacitances of the wiring, leading to a malfunction of the overcurrent protective function, fast response current limit function, or stall prevention function or a malfunction or fault of the equipment connected on the inverter output side. If malfunction of fast-response current limit function occurs, disable this function. If malfunction of stall prevention function occurs, increase the stall level. ( *Pr. 22 Stall prevention operation level* and *Pr. 156 Stall prevention operation selection in Chapter 4 of the Instruction Manual (Applied)*)
- When using the automatic restart after instantaneous power failure function with the wiring length exceeding 100m, select without frequency search (*Pr. 162 = "1, 11"*). ( *Refer to Chapter 4 of the Instruction Manual (Applied)*)

2.3.4 Wiring of control circuit

(1) Control circuit terminal layout

Recommend wire size:
0.3mm² to 0.75mm²

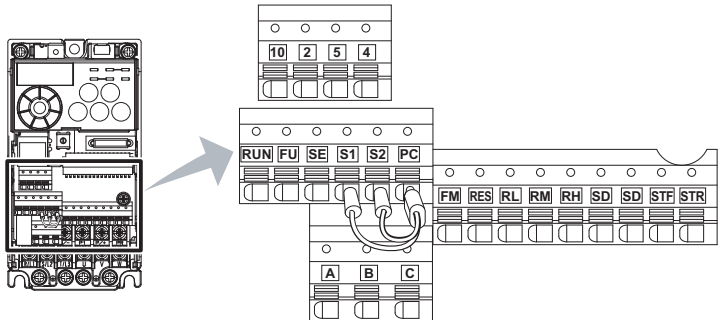

(2) Wiring method

●Wiring

Use a blade terminal and a wire with a sheath stripped off for the control circuit wiring. For a single wire, strip off the sheath of the wire and apply directly.

Insert the blade terminal or the single wire into a socket of the terminal.

- Strip off the sheath about the size below. If the length of the sheath peeled is too long, a short circuit may occur among neighboring wires. If the length is too short, wires might come off. Wire the stripped wire after twisting it to prevent it from becoming loose. In addition, do not solder it.

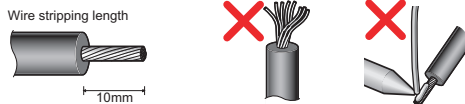

- Crimp the blade terminal. Insert wires to a blade terminal, and check that the wires come out for about 0 to 0.5 mm from a sleeve. Check the condition of the blade terminal after crimping. Do not use a blade terminal of which the crimping is inappropriate, or the face is damaged.

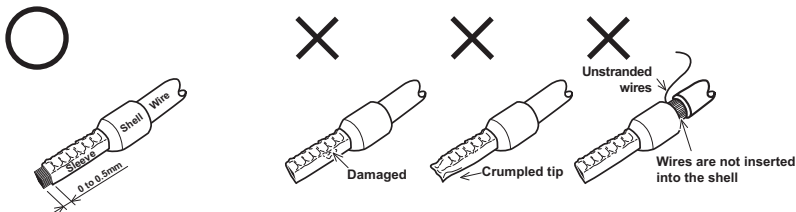

Blade terminals available on the market: (as of Jan. 2010)

●Phoenix Contact Co.,Ltd.

Wire Size (mm ²)	Blade Terminal Model			Blade terminal crimping tool
	with insulation sleeve	without insulation sleeve	for UL wire ^{*1}	
0.3	AI 0,5-10WH	—	—	CRIMPFOX 6
0.5	AI 0,5-10WH	—	AI 0,5-10WH-GB	
0.75	AI 0,75-10GY	A 0,75-10	AI 0,75-10GY-GB	
1	AI 1-10RD	A1-10	AI 1-10RD/1000GB	
1.25, 1.5	AI 1,5-10BK	A1,5-10	AI 1,5-10BK/1000GB ^{*2}	
0.75 (for two wires)	AI-TWIN 2 x 0,75-10GY	—	—	

^{*1} A blade terminal with an insulation sleeve compatible with MTW wire which has a thick wire insulation
^{*2} Applicable for terminal ABC.

●NICHIFU Co.,Ltd.

Wire Size (mm ²)	Blade terminal product number	Insulation product number	Blade terminal crimping tool
0.3 to 0.75	BT 0.75-11	VC 0.75	NH 67

3) Insert the wire into a socket.

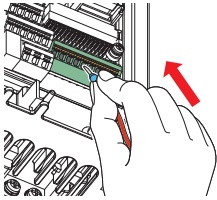

When using a single wire or a stranded wire without a blade terminal, push an open/close button all the way down with a flathead screw driver, and insert the wire.

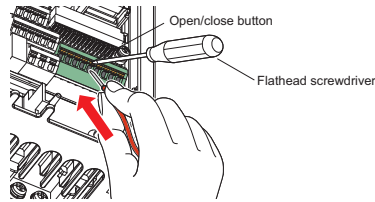

NOTE

- When using a stranded wire without a blade terminal, twist enough to avoid short circuit with a nearby terminals or wires.
- Place the flathead screwdriver vertical to the open/close button. In case the blade tip slips, it may cause to damage of inverter or injury.

●Wire removal

Pull the wire with pushing the open/close button all the way down firmly with a flathead screwdriver.

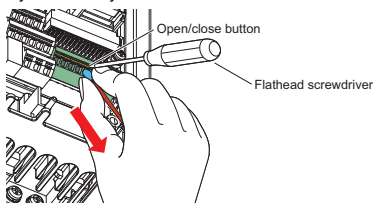

NOTE

- Pulling out the terminal block forcefully without pushing the open/close button all the way down may damage the terminal block.
 - Use a small flathead screwdriver (Tip thickness: 0.4mm/ tip width: 2.5mm). If a flathead screwdriver with a narrow tip is used, terminal block may be damaged.
- Products available on the market : (as of Jan. 2010)

Product	Type	Maker
Flathead screwdriver	SZF 0- 0,4 x 2,5	Phoenix Contact Co.,Ltd.

- Place the flathead screwdriver vertical to the open/close button. In case the blade tip slips, it may cause to damage of inverter or injury.

(3) Control circuit common terminals (SD, 5, SE)

Terminals SD, SE and 5 are common terminals for I/O signals. (All common terminals are isolated from each other.) Do not earth them. Avoid connecting the terminals SD and 5 and the terminals SE and 5.

Terminal SD is a common terminal for the contact input terminals (STF, STR, RH, RM, RL, RES) and frequency output signal (FM). The open collector circuit is isolated from the internal control circuit by photocoupler.

Terminal 5 is a common terminal for the frequency setting signals (terminal 2 or 4). It should be protected from external noise using a shielded or twisted wire.

Terminal SE is a common terminal for the open collector output terminal (RUN, FU). The contact input circuit is isolated from the internal control circuit by photocoupler.

(4) Wiring instructions

- 1) It is recommended to use the wires of 0.3mm² to 0.75mm² gauge for connection to the control circuit terminals.
- 2) The maximum wiring length should be 30m (200m for terminal FM).
- 3) Do not short terminals PC and SD. Inverter may be damaged.
- 4) Use two or more parallel micro-signal contacts or twin contacts to prevent contact faults when using contact inputs since the control circuit input signals are micro-currents.
- 5) Use shielded or twisted wires for connection to the control circuit terminals and run them away from the main and power circuits (including the 200V relay sequence circuit).
- 6) Do not apply a voltage to the contact input terminals (e.g. STF) of the control circuit.
- 7) Always apply a voltage to the fault output terminals (A, B, C) via a relay coil, lamp, etc.

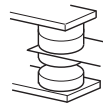

Micro signal contacts

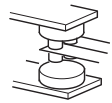

Twin contacts

2.3.5 Safety stop function

(1) Description of the function

The terminals related to the safety stop function are shown below.

Terminal Symbol	Description	
S1 *1	For input of safety stop channel 1.	Between S1 and PC / S2 and PC Open: In safety stop state. Short: Other than safety stop state.
S2 *1	For input of safety stop channel 2.	
PC *1	Common terminal for terminal S1 and S2.	
FU *2	SAFE signal	Outputs the safety stop status The signal is output when inverter output is shut off due to the safety stop function.
RUN *3	SAFE2 signal	Outputs when an alarm or failure is detected. The signal is output when no internal safety circuit failure*4 exists.
SE	Common terminal for open collector outputs (terminal RUN and FU)	

- *1 In the initial status, terminal S1 and S2 are shorted with terminal PC by shortening wire. Remove the shortening wire and connect the safety relay module when using the safety stop function.
- *2 In the initial setting, output frequency detection (FU signal) is assigned to terminal FU. Set "80" to Pr.191 FU terminal function selection to assign SAFE signal. The function can be assigned to other terminals by setting "80 (positive logic) or 180 (negative logic)" to any of Pr.190 to Pr.192 (Output terminal function selection). (Refer to the Instruction Manual (Applied))
- *3 In the initial setting, inverter running (RUN signal) is assigned to terminal RUN. Set "81" to Pr.190 RUN terminal function selection to assign SAFE2 signal. The function can be assigned to other terminals by setting "81 (positive logic) or 181 (negative logic)" to any of Pr.190 to Pr.192 (Output terminal function selection). (Refer to the Instruction Manual (Applied))
- *4 At an internal safety circuit failure, one of E.SAF, E.6, E.7, and E.CPU is displayed on the operation panel.

2



NOTE

- Hold the ON or OFF status for 2ms or longer to input signal to terminal S1 or S2. Signal input shorter than 2ms is not recognized.
- Use SAFE signal to monitor safety stop status. SAFE signal cannot be used as safety stop input signal to other devices (other than the safety relay module).
- SAFE 2 signal can only be used to output an alarm or to prevent restart of an inverter. The signal cannot be used as safety stop input signal to other devices.

(2) Wiring connection diagram

To prevent restart at fault occurrence, connect terminals RUN (SAFE 2 signal) and SE to terminals XS0 and XS1, which are the feedback input terminals of the safety relay module.

By setting Pr. 190 RUN terminal function selection = "81 (SAFE2 signal)", terminal RUN is turned OFF at fault occurrence.

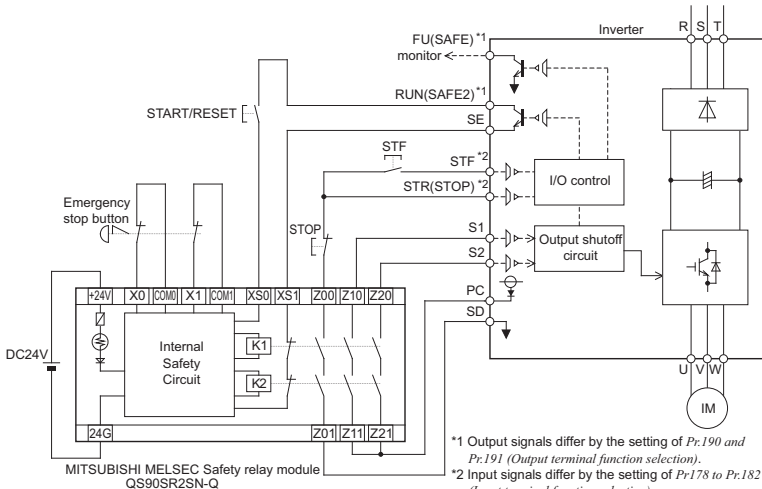

- *1 Output signals differ by the setting of Pr.190 and Pr.191 (Output terminal function selection).
- *2 Input signals differ by the setting of Pr.178 to Pr.182 (Input terminal function selection).



NOTE

- Changing the terminal assignment using Pr. 190 to Pr. 192 (output terminal function selection) may affect the other functions. Set parameters after confirming the function of each terminal.

(3) Safety stop function operation

Input power	Input signal		Internal safety circuit ^{*1}	Output signal		Inverter operation enable signal
	S1-PC	S2-PC		SAFE ^{*3}	SAFE2 ^{*3}	
OFF	—	—	—	OFF	OFF	Output shutoff (Safe state)
ON	Short	Short	No failure	OFF	ON	Drive enabled
			Failure	OFF	OFF	Output shutoff (Safe state)
	Open	Open	No failure ^{*2}	ON	ON	Output shutoff (Safe state)
			Failure	OFF	OFF	Output shutoff (Safe state)
	Short	Open	Failure	OFF	OFF	Output shutoff (Safe state)
Open	Short	Failure	OFF	OFF	Output shutoff (Safe state)	

*1 At an internal safety circuit failure, one of E.SAF, E.6, E.7, and E.CPU is displayed on the operation panel.

*2 SA is displayed when both of the S1 and S2 signals are in open status and no internal safety circuit failure exists.

*3 ON: Transistor used for an open collector output is conducted.

OFF: Transistor used for an open collector output is not conducted.

For more details, refer to the Safety stop function instruction manual (BCN-A211508-004). (Please contact your sales representative for the manual.)

2.4 Connection of a dedicated external brake resistor (MRS type, MYS type, FR-ABR)

Install a dedicated brake resistor (MRS type, MYS type, FR-ABR) outside when the motor driven by the inverter is made to run by the load, quick deceleration is required, etc. Connect a dedicated brake resistor (MRS type, MYS type, FR-ABR) to terminals P/+ and PR. (For the locations of terminals P/+ and PR, refer to the terminal block layout (page 12).)

Set parameters below. (Refer to the Instruction Manual (Applied) for the parameter details.)

Connected Brake Resistor	Pr. 30 Regenerative function selection Setting	Pr. 70 Special regenerative brake duty Setting	
MRS type, MYS type	0 (initial value)	—	
MYS type (used at 100% torque/6%ED)	1	6%	
FR-ABR	1	7.5K or lower	10%
		11K or higher	6%

It is recommended to configure a sequence, which shuts off power in the input side of the inverter by the external thermal relay as shown below, to prevent overheat and burnout of the brake resistor (MRS, MYS) and high duty brake resistor (FR-ABR) in case the regenerative brake transistor is damaged. (The brake resistor can not be connected to the 0.1K or 0.2K.)

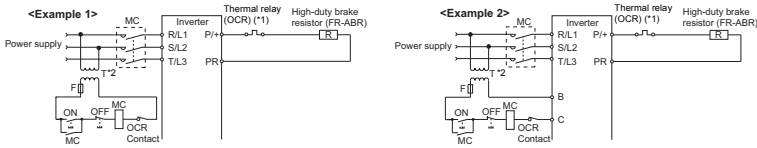

- *1 Refer to the table below for the type number of each capacity of thermal relay and the diagram below for the connection.
(Always install a thermal relay when using a brake resistor whose capacity is 11K or higher.)
- *2 When the power supply is 400V class, install a step-down transformer.

Power Supply Voltage	Brake Resistor	Thermal Relay Type (Mitsubishi product)	Contact Rating
200V	MRS120W200	TH-N20CXHZ-0.7A	110VAC 5A, 220VAC 2A (AC11 class) 110VDC 0.5A, 220VDC 0.25A (DC11 class)
	MRS120W100	TH-N20CXHZ-1.3A	
	MRS120W60	TH-N20CXHZ-2.1A	
	MRS120W40	TH-N20CXHZ-3.6A	
	MYS220W50 (two units in parallel)	TH-N20CXHZ-5A	

Power Supply Voltage	Brake Resistor	Thermal Relay Type (Mitsubishi product)	Contact Rating
200V	FR-ABR-0.4K	TH-N20CXHZ-0.7A	110VAC 5A 220VAC 2A (AC11 class) 110VDC 0.5A, 220VDC 0.25A (DC11 class)
	FR-ABR-0.75K	TH-N20CXHZ-1.3A	
	FR-ABR-2.2K	TH-N20CXHZ-2.1A	
	FR-ABR-3.7K	TH-N20CXHZ-3.6A	
	FR-ABR-5.5K	TH-N20CXHZ-5A	
	FR-ABR-7.5K	TH-N20CXHZ-6.6A	
	FR-ABR-11K	TH-N20CXHZ-11A	
	FR-ABR-15K	TH-N20CXHZ-11A	
400V	FR-ABR-H0.4K	TH-N20CXHZ-0.24A	110VAC 5A 220VAC 2A (AC11 class) 110VDC 0.5A, 220VDC 0.25A (DC11 class)
	FR-ABR-H0.75K	TH-N20CXHZ-0.35A	
	FR-ABR-H1.5K	TH-N20CXHZ-0.9A	
	FR-ABR-H2.2K	TH-N20CXHZ-1.3A	
	FR-ABR-H3.7K	TH-N20CXHZ-2.1A	
	FR-ABR-H5.5K	TH-N20CXHZ-2.5A	
	FR-ABR-H7.5K	TH-N20CXHZ-3.6A	
	FR-ABR-H11K	TH-N20CXHZ-6.6A	
	FR-ABR-H15K	TH-N20CXHZ-6.6A	

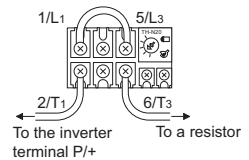

Note

- The brake resistor connected should only be the dedicated brake resistor.
- Perform wiring and operation according to the Instruction Manual of each option unit.
- Brake resistor can not be used with the brake unit, high power factor converter, power supply regeneration converter, etc.
- Do not use the brake resistor (MRS type, MYS type) with a lead wire extended.
- Do not connect the resistor directly to the terminals P/+ and N/-. This could cause a fire.

3 PRECAUTIONS FOR USE OF THE INVERTER

The FR-E700 series is a highly reliable product, but incorrect peripheral circuit making or operation/handling method may shorten the product life or damage the product.

Before starting operation, always recheck the following points.

- (1) **Use crimping terminals with insulation sleeve to wire the power supply and motor.**
- (2) **Application of power to the output terminals (U, V, W) of the inverter will damage the inverter. Never perform such wiring.**
- (3) **After wiring, wire offcuts must not be left in the inverter.**

Wire offcuts can cause an alarm, failure or malfunction. Always keep the inverter clean.
When drilling mounting holes in an enclosure etc., take care not to allow chips and other foreign matter to enter the inverter.
- (4) **Use cables of the size to make a voltage drop 2% or less.**

If the wiring distance is long between the inverter and motor, a main circuit cable voltage drop will cause the motor torque to decrease especially at the output of a low frequency.
Refer to page 13 for the recommended wire sizes.
- (5) **The overall wiring length should be 500m or less.**

Especially for long distance wiring, the fast-response current limit function may decrease or the equipment connected to the secondary side may malfunction or become faulty under the influence of a charging current due to the stray capacity of the wiring. Therefore, note the overall wiring length. (*Refer to page 14*)
- (6) **Electromagnetic wave interference**

The input/output (main circuit) of the inverter includes high frequency components, which may interfere with the communication devices (such as AM radios) used near the inverter. In this case, install options among the capacitor type EMC filter FR-BIF (for use in the input side only), the ferrite core type EMC filter FR-BSF01/FR-BLF, filterpack, and EMC filter to minimize the interference.
- (7) **Do not install a power factor correction capacitor, surge suppressor or capacitor type filter on the inverter output side.**

This will cause the inverter to trip or the capacitor and surge suppressor to be damaged. If any of the above devices are connected, immediately remove them. (When using capacitor type filter (FR-BIF) for single-phase power input model, make sure of secure insulation of T-phase, and connect to the input side of the inverter.)
- (8) **For some short time after the power is switched OFF, a high voltage remains in the smoothing capacitor.**

When accessing the inverter for inspection, wait for at least 10 minutes after the power supply has been switched OFF, and then make sure that the voltage across the main circuit terminals P/+ and N/- of the inverter is not more than 30VDC using a tester, etc. The capacitor is charged with high voltage for some time after power OFF and it is dangerous.
- (9) **If "EV" is displayed on the operation panel, turn off the 24V external power supply before wiring and inspection.**
- (10) **A short circuit or earth (ground) fault on the inverter output side may damage the inverter modules.**
 - Fully check the insulation resistance of the circuit prior to inverter operation since repeated short circuits caused by peripheral circuit inadequacy or an earth (ground) fault caused by wiring inadequacy or reduced motor insulation resistance may damage the inverter modules.
 - Fully check the to-earth (ground) insulation and phase to phase insulation of the inverter output side before power-ON. Especially for an old motor or use in hostile atmosphere, securely check the motor insulation resistance etc.
- (11) **Do not use the inverter input side magnetic contactor to start/stop the inverter.**

Since repeated inrush currents at power ON will shorten the life of the converter circuit (switching life is about 1,000,000 times), frequent starts and stops of the MC must be avoided. Turn ON/OFF the inverter start controlling terminals (STF, STR) to run/stop the inverter. (🔌 *Refer to the Instruction Manual (Applied)*)

(12) Across terminals P/+ and PR, connect only an external regenerative brake discharging resistor.

Do not connect a mechanical brake.

The brake resistor can not be connected to the 0.1KSC or 0.2KSC. Leave terminals P/+ and PR open.

Also, never short between these terminals.

(13) Do not apply a voltage higher than the permissible voltage to the inverter I/O signal circuits.

Application of a voltage higher than the permissible voltage to the inverter I/O signal circuits or opposite polarity may damage the I/O devices. Especially check the wiring to prevent the speed setting potentiometer from being connected incorrectly to short terminals 10 and 5.

(14) Provide electrical and mechanical interlocks for MC1 and MC2 which are used for bypass operation.

When the wiring is incorrect and if there is a bypass operation circuit as shown right, the inverter will be damaged when the power supply is connected to the inverter U, V, W terminals, due to arcs generated at the time of switch-over or chattering caused by a sequence error.

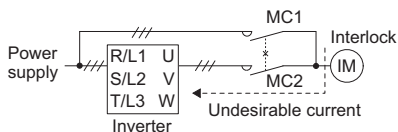

(15) If the machine must not be restarted when power is restored after a power failure, provide a magnetic contactor in the inverter's input side and also make up a sequence which will not switch ON the start signal.

If the start signal (start switch) remains ON after a power failure, the inverter will automatically restart as soon as the power is restored.

(16) Inverter input side magnetic contactor (MC)

On the inverter input side, connect a MC for the following purposes. (Refer to *page 7* for selection.)

- 1) To release the inverter from the power supply when a fault occurs or when the drive is not functioning (e.g. emergency stop operation). For example, MC avoids overheating or burnout of the brake resistor when the heat capacity of the resistor is insufficient or the brake regenerative transistor is damaged with short while connecting an optional brake resistor.
- 2) To prevent any accident due to an automatic restart at restoration of power after an inverter stop made by a power failure
- 3) To separate the inverter from the power supply to ensure safe maintenance and inspection work.

The inverter's input side MC is used for the above purpose, select class JEM1038-AC3 MC for the inverter input side current when making an emergency stop during normal operation.

(17) Handling of inverter output side magnetic contactor

Switch the magnetic contactor between the inverter and motor only when both the inverter and motor are at a stop. When the magnetic contactor is turned ON while the inverter is operating, overcurrent protection of the inverter and such will activate. When MC is provided for switching to the commercial power supply, for example, switch it ON/OFF after the inverter and motor have stopped.

(18) Countermeasures against inverter-generated EMI

If electromagnetic noise generated from the inverter causes frequency setting signal to fluctuate and motor rotation speed to be unstable when changing motor speed with analog signal, the following countermeasures are effective.

- Do not run the signal cables and power cables (inverter I/O cables) in parallel with each other and do not bundle them.
- Run signal cables as far away as possible from power cables (inverter I/O cables).
- Use shield cables as signal cables.
- Install a ferrite core on the signal cable (Example: ZCAT3035-1330 TDK).

(19) Instructions for overload operation

When performing operation of frequent start/stop of the inverter, rise/fall in the temperature of the transistor element of the inverter will repeat due to a repeated flow of large current, shortening the life from thermal fatigue. Since thermal fatigue is related to the amount of current, the life can be increased by reducing current at locked condition, starting current, etc. Decreasing current may increase the life. However, decreasing current will result in insufficient torque and the inverter may not start. Therefore, choose the inverter which has enough allowance for current (up to 2 rank larger in capacity).

(20) Make sure that the specifications and rating match the system requirements.

4 FAILSAFE OF THE SYSTEM WHICH USES THE INVERTER

When a fault occurs, the inverter trips to output a fault signal. However, a fault output signal may not be output at an inverter fault occurrence when the detection circuit or output circuit fails, etc. Although Mitsubishi assures best quality products, provide an interlock which uses inverter status output signals to prevent accidents such as damage to machine when the inverter fails for some reason and at the same time consider the system configuration where failsafe from outside the inverter, without using the inverter, is enabled even if the inverter fails.

(1) Interlock method which uses the inverter status output signals

By combining the inverter status output signals to provide an interlock as shown below, an inverter alarm can be detected.

No.	Interlock Method	Check Method	Used Signals	Refer to Page
1)	Inverter protective function operation	Operation check of an alarm contact Circuit error detection by negative logic	Fault output signal (ALM signal)	Refer to Chapter 4 of the Instruction Manual (Applied).
2)	Inverter running status	Operation ready signal check	Operation ready signal (RY signal)	Refer to Chapter 4 of the Instruction Manual (Applied).
3)	Inverter running status	Logic check of the start signal and running signal	Start signal (STF signal, STR signal) Running signal (RUN signal)	Refer to Chapter 4 of the Instruction Manual (Applied).
4)	Inverter running status	Logic check of the start signal and output current	Start signal (STF signal, STR signal) Output current detection signal (Y12 signal)	Refer to Chapter 4 of the Instruction Manual (Applied).

(2) Backup method outside the inverter

Even if the interlock is provided by the inverter status signal, enough failsafe is not ensured depending on the failure status of the inverter itself. For example, when the inverter CPU fails, even if the interlock is provided using the inverter fault output signal, start signal and RUN signal output, there is a case where a fault output signal is not output and RUN signal is kept output even if an inverter fault occurs.

Provide a speed detector to detect the motor speed and current detector to detect the motor current and consider the backup system such as checking up as below according to the level of importance of the system.

1) Start signal and actual operation check

Check the motor running and motor current while the start signal is input to the inverter by comparing the start signal to the inverter and detected speed of the speed detector or detected current of the current detector. Note that the motor current runs as the motor is running for the period until the motor stops since the inverter starts decelerating even if the start signal turns off. For the logic check, configure a sequence considering the inverter deceleration time. In addition, it is recommended to check the three-phase current when using the current detector.

2) Command speed and actual operation check

Check if there is no gap between the actual speed and commanded speed by comparing the inverter speed command and detected speed of the speed detector.

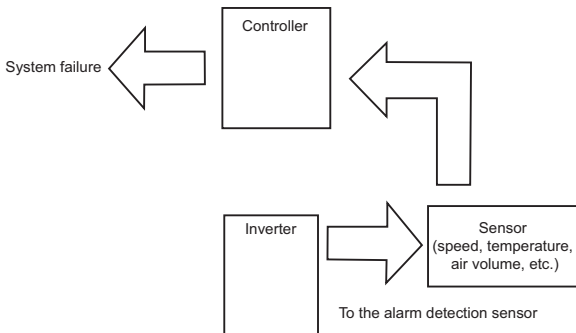

5 DRIVING THE MOTOR

The inverter needs frequency command and start command.
 Frequency command (set frequency) determines the rotation speed of the motor.
 Turning ON the start command starts the motor to rotate.

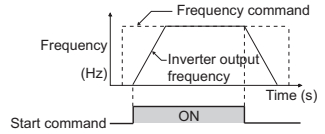

REMARKS

- Set the required parameters according to the load and operating conditions. (Refer to page 34.)

5.1 Start/stop from the operation panel (PU operation)



POINT

From where is the frequency command given?

- Operation at the frequency set in the frequency setting mode of the operation panel (Refer to 5.1.1 (Refer to page 23))
- Operation using the setting dial as the potentiometer (Refer to Chapter 4 of the Instruction Manual (Applied))
- Change of frequency with ON/OFF switches connected to terminals (Refer to 5.1.2 (Refer to page 24))
- Perform frequency setting using voltage input signal (Refer to 5.1.3 (Refer to page 25))
- Perform frequency setting using current input signal (Refer to Chapter 4 of the Instruction Manual (Applied))

5.1.1 Setting the frequency by the operation panel

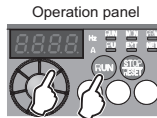

Operation example Operate at 30Hz.

Operation

1. Screen at power-ON

The monitor display appears.

2. Operation mode change

Press **PU/EXT** to choose the PU operation mode. PU indicator is lit.

Frequency setting

- Turn **▲** to show the frequency "30.00" (30.00Hz) you want to set. The frequency flickers for about 5s. While the value is flickering, press **SET** to set the frequency. "F" and "30.00" flicker alternately. After about 3s of flickering, the display of the value goes back to "0.00" (0.00Hz) (monitor display). (If **SET** is not pressed, the display of the value goes back to "0.00" (0.00Hz) after about 5s of flickering. In that case, turn **▲** again, and set the frequency.)

Start → acceleration → constant speed

4. Press **RUN** to start operation.

The frequency value on the display increases in Pr. 7 Acceleration time, and "30.00" (30.00Hz) appears. (To change the set frequency, perform the operation in above step 3. The previously set frequency is displayed at first.)

Deceleration → stop

5. Press **STOP/RESET** to stop. The frequency value on the display decreases in Pr. 8 Deceleration time, and the motor stops running with "0.00" (0.00Hz) displayed.



REMARKS

- ▲** can also be used like a potentiometer to perform operation. (Refer to Chapter 4 of the Instruction Manual (Applied).)
- When you always operate in the PU operation mode at power-ON, set Pr.79 Operation mode selection = "1" to choose the PU operation mode always.

5.1.2 Setting the frequency by switches (three-speed setting) (Pr. 4 to Pr. 6)



POINT

- Use the operation panel () to give a start command.
- Switch ON the RH, RM, or RL signal to give a frequency command.
- Set "4" (External/PU combined operation mode 2) in Pr. 79 Operation mode selection.

[Connection diagram]

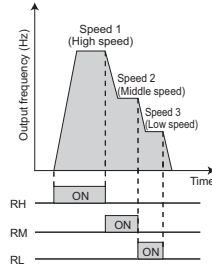
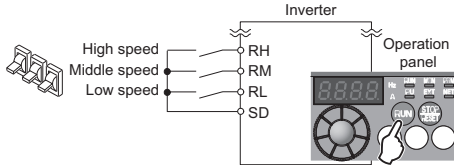

Operation example Operation at low speed (10Hz)

Operation

1. **Screen at power-ON**
The monitor display appears.
2. **Easy operation mode setting**
Press and for 0.5s. " " appears, and the [PRM] indicator flickers.
3. **Operation mode selection**
Turn until " " appears. [PU] and [PRM] indicators flicker.
4. **Operation mode setting**
Press to enter the setting. (Set "4" in Pr.79.)
" " and " " flicker alternately. [PU] and [EXT] indicators are lit.
5. **Start**
Turn ON the low-speed switch (RL).
6. **Acceleration → constant speed**
Press to start running.
The frequency value on the display increases in Pr. 7 Acceleration time, and " " (10.00Hz) appears.
[RUN] indicator is lit during forward rotation operation and flickers slowly during reverse rotation operation.
7. **Deceleration**
Press to stop.
The frequency value on the display decreases in Pr. 8 Deceleration time, and the motor stops running with " " (0.00Hz) displayed.
8. **Stop**
Turn OFF the low-speed switch (RL).



REMARKS

- The initial values of the terminals RH, RM, RL are 60Hz, 30Hz, and 10Hz. (Use Pr. 4, Pr. 5 and Pr. 6 to change.)
- In the initial setting, when two or three of multi-speed settings are simultaneously selected, priority is given to the set frequency of the lower signal.
For example, when the RH and RM signals turn ON, the RM signal (Pr. 5) has a higher priority.
- Maximum of 15-speed operation can be performed. (Refer to Chapter 4 of the Instruction Manual (Applied).)

5.1.3 Setting the frequency by analog input (voltage input)



POINT

- Use the operation panel () to give a start command.
- Use the (frequency setting) potentiometer to give a frequency command.
- Set "4" (External/PU combined operation mode 2) in *Pr. 79 Operation mode selection*.

[Connection diagram]

(The inverter supplies 5V power to the frequency setting potentiometer. (terminal 10))

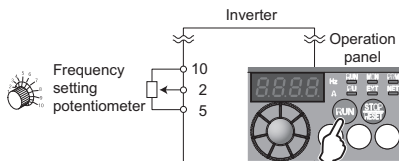



Operation example Operate at 60Hz.

Operation



1. Screen at power-ON

The monitor display appears.



2. Easy operation mode setting

Press  and  for 0.5s. "  - - " appears, and the [PRM] indicator flickers.

Operation mode selection

3. Turn  until "  - 4 " appears. [PU] and [PRM] indicators flicker.

Operation mode setting

4. Press  to enter the setting. (Set "4" in *Pr.79*.)
"  - 4 " and "  - - " flicker alternately. [PU] and [EXT] indicators are lit.

Start

5. Press . [RUN] flickers fast as no frequency command is given.

Acceleration → constant speed

6. Turn the potentiometer clockwise slowly to full.
The frequency value on the display increases in *Pr. 7 Acceleration time*, and "  0.00 " (60.00Hz) appears.
[RUN] indicator is lit during forward rotation operation and flickers slowly during reverse rotation operation.

Deceleration

7. Turn the potentiometer counterclockwise slowly to full.
The frequency value on the display decreases in *Pr. 8 Deceleration time*, and the motor stops running with "  0.00 " (0.00Hz) displayed. [RUN] flickers fast.

Stop

8. Press . [RUN] indicator turns OFF.



REMARKS

- The frequency at the full clockwise turn of the potentiometer (frequency setting potentiometer) (maximum potentiometer setting) is 60Hz in the initial setting. (To change the setting, use *Pr.125*.) (Refer to page 29.)

5.2 Start and stop using terminals (External operation)



POINT

From where is the frequency command given?

- Operation at the frequency set in the frequency setting mode of the operation panel (refer to 5.2.1 (Refer to page 26))
- Give a frequency command by switch (multi-speed setting) (refer to 5.2.2 (Refer to page 27))
- Perform frequency setting by a voltage input signal (refer to 5.2.3 (Refer to page 28))
- Perform frequency setting by a current input signal (refer to Chapter 4 of the Instruction Manual (Applied))

5.2.1 Setting the frequency by the operation panel (Pr. 79 = 3)



POINT

- Switch ON the STF(STR) signal to give a start command.
- Use the operation panel () to give a frequency command.
- Set "3" (External/PU combined operation mode 1) in Pr. 79.

[Connection diagram]

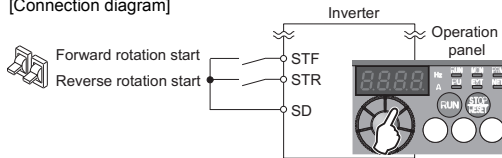

Operation example Operate at 30Hz.

Operation

- Screen at power-ON
The monitor display appears.
- Easy operation mode setting
Press (PU/EXT) and (MODE) for 0.5s. "79 - -" appears, and the [PRM] indicator flickers.
- Operation mode selection
Turn () until "79 - 3" appears. [EXT] and [PRM] indicators flicker.
- Operation mode setting
Press (SET) to enter the setting. (Set "3" in Pr.79.)
"79 - 3" and "79 - -" flicker alternately. [PU] and [EXT] indicators are lit.
- Frequency setting
Turn () to show the frequency "3000" you want to set. The frequency flickers for about 5s. While the value is flickering, press (SET) to set the frequency. "F" and "3000" flicker alternately. After about 3s of flickering, the display of the value goes back to "000" (monitor display). (If (SET) is not pressed, the display of the value goes back to "000" (0.00Hz) after about 5s of flickering. In that case, turn () again, and set the frequency.)
- Start → acceleration → constant speed
Turn the start switch (STF or STR) ON.
The frequency value on the display increases in Pr. 7 Acceleration time, and "3000" (30.00Hz) appears. [RUN] indicator is lit during forward rotation operation and flickers during reverse rotation operation. (To change the set frequency, perform the operation in above step 5. Starting from the previously set frequency.)
- Deceleration → stop
Turn OFF the start switch (STF or STR). The frequency value on the display decreases in Pr. 8 Deceleration time, and the motor stops running with "000" displayed. [RUN] turns OFF.

5.2.2 Setting the frequency by switches (three-speed setting) (Pr. 4 to Pr. 6)



POINT

- Switch ON the STF (STR) signal to give a start command.
- Switch ON the RH, RM, or RL signal to give a frequency command.

[Connection diagram]

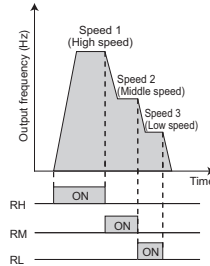
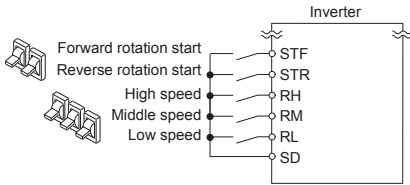

Operation example Operation at high speed (60Hz)

Operation

- 1. Screen at power-ON**
The monitor display appears.
- 2. Start**
Turn ON the high-speed switch (RH).
Acceleration → constant speed
- 3.** Turn ON the start switch (STF or STR). The frequency value on the display increases in *Pr. 7 Acceleration time*, and "60.00" (60.00Hz) appears.
[RUN] indicator is lit during forward rotation operation and flickers during reverse rotation operation.
 - When RM is turned ON, 30Hz is displayed. When RL is turned ON, 10Hz is displayed.
 Deceleration
- 4.** Turn OFF the start switch (STF or STR). The frequency value on the display decreases in *Pr. 8 Deceleration time*, and the motor stops running with "0.00" (0.00Hz) displayed. [RUN] turns OFF.
- 5. Stop**
Turn OFF the high-speed switch (RH)



REMARKS

- Initial values of terminals RH, RM, and RL are 60Hz, 30Hz, and 10Hz. (To change, set *Pr. 4*, *Pr. 5* and *Pr. 6*.)
- In the initial setting, when two or three of multi-speed settings are simultaneously selected, priority is given to the set frequency of the lower signal.
For example, when the RH and RM signals turn ON, the RM signal (*Pr. 5*) has a higher priority.
- Maximum of 15-speed operation can be performed. (Refer to Chapter 4 of the Instruction Manual (Applied).)

5.2.3 Setting the frequency by analog input (voltage input)



POINT

- Switch ON the STF(STR) signal to give a start command.
- Use the potentiometer (frequency setting potentiometer) to give a frequency command.

[Connection diagram]
 (The inverter supplies 5V power to the frequency setting potentiometer. (terminal 10))

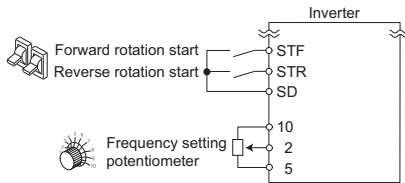

Operation example Operate at 60Hz.

Operation

- 1. Screen at power-ON**
The monitor display appears.
- Start**
Turn the start switch (STF or STR) ON.
[RUN] flickers fast because the frequency command is not given.
- Acceleration → constant speed**
Turn the potentiometer (frequency setting potentiometer) clockwise slowly to full.
The frequency value on the display increases in *Pr. 7 Acceleration time*, and "60.00" (60.00Hz) appears.
[RUN] indicator is lit during forward rotation operation and flickers slowly during reverse rotation operation.
- Deceleration**
Turn the potentiometer (frequency setting potentiometer) counterclockwise slowly to full.
The frequency value on the display decreases in *Pr. 8 Deceleration time*, and the motor stops running with "0.00" (0.00Hz) displayed. [RUN] flickers fast.
- Stop**
Turn the start switch (STF or STR) OFF.
[RUN] turns OFF.



REMARKS





- The frequency at the full clockwise turn of the potentiometer (frequency setting potentiometer) (maximum potentiometer setting) is 60Hz in the initial setting. (To change the setting, use *Pr.125.*) (Refer to page 29.)

5.2.4 Operating at 60Hz or higher using the external potentiometer

< How to change the maximum frequency >

Changing example When you want to use 0 to 5VDC input frequency setting potentiometer to change the frequency at 5V from 60Hz (initial value) to 70Hz, make adjustment to output "70Hz" at 5V voltage input. Set "70Hz" in Pr. 125.

Operation

1. **Parameter selection**
Turn  until "P. 125" (Pr. 125) appears.
Press  to show the present set value "60.00" (60.00Hz).
2. **Changing the maximum frequency**
Turn  to change the set value to "70.00" (70.00Hz).
Press  to enter. "70.00" and "P. 125" flicker alternately.
3. **Mode/monitor check**
Press  twice to choose the monitor/frequency monitor.
4. **Start**
Turn the start switch (STF or STR) ON.
[RUN] flickers fast because the frequency command is not given.
5. **Acceleration → constant speed**
Turn the potentiometer (frequency setting potentiometer) clockwise slowly to full.
The frequency value on the display increases in Pr. 7 Acceleration time, and "70.00" (70.00Hz) appears.
[RUN] indicator is lit during forward rotation operation and flickers slowly during reverse rotation operation.
6. **Deceleration**
Turn the potentiometer (frequency setting potentiometer) counterclockwise slowly to full.
The frequency value on the display decreases in Pr. 8 Deceleration time, and the motor stops running with "00.00" (0.00Hz) displayed. [RUN] flickers fast.
7. **Stop**
Turn the start switch (STF or STR) OFF.
[RUN] turns OFF.

5

REMARKS

To change the value to 120Hz or more, the maximum frequency must be set to 120Hz or more.

? Use calibration parameter C2 to set frequency at 0V and calibration parameter C0 to adjust the meter.

( Refer to Chapter 4 of the Instruction Manual (Applied)).

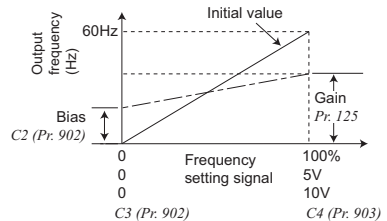

As other adjustment methods of frequency setting voltage gain, there are methods to adjust with a voltage applied to across terminals 2 and 5 and a method to adjust at any point without a voltage applied. ( Refer to Chapter 4 of the Instruction Manual (Applied) for the setting method of calibration parameter C4.)

5.3 Acquiring large starting torque and low speed torque (Advanced magnetic flux vector control, General-purpose magnetic flux vector control) (Pr. 71, Pr. 80, Pr. 81, Pr. 800)

Advanced magnetic flux vector control can be selected by setting the capacity, poles and type of the motor used in Pr. 80 and Pr. 81.

- Advanced magnetic flux vector control, General-purpose magnetic flux vector control?

The low speed torque can be improved by providing voltage compensation to flow a motor current which meets the load torque. Output frequency compensation (slip compensation) is made so that the motor actual speed approximates a speed command value. Effective when load fluctuates drastically, etc.

General-purpose magnetic flux vector control is the same function as it is for the FR-E500 series. Select this control when operation characteristics as similar as possible are required when replacing from the FR-E500 series. For other cases, select Advanced magnetic flux vector control.

Parameter Number	Name	Initial Value	Setting Range	Description
71	Applied motor	0	0, 1, 3 to 6, 13 to 16, 23, 24 40, 43, 44 50, 53, 54	By selecting a standard motor or constant-torque motor, thermal characteristic and motor constants of each motor are set.
80	Motor capacity	9999	0.1 to 15kW	Set the applied motor capacity.
			9999	V/F control
81	Number of motor poles	9999	2, 4, 6, 8, 10	Set the number of motor poles.
			9999	V/F control
800	Control method selection	20	20	Advanced magnetic flux vector control *
			30	General-purpose magnetic flux vector control *

* Set a value other than "9999" in Pr. 80 and Pr. 81.



POINT

If the following conditions are not satisfied, select V/F control since malfunction such as insufficient torque and uneven rotation may occur.

- The motor capacity should be equal to or one rank lower than the inverter capacity. (Note that the capacity should be 0.1kW or higher.)
- Motor to be used is any of Mitsubishi standard motor (SF-JR 0.2kW or more), high efficiency motor (SF-HR 0.2kW or more) or Mitsubishi constant-torque motor (SF-JRCA four-pole, SF-HRCA 0.2kW to 15kW). When using a motor other than the above (other manufacturer's motor), perform offline auto tuning without fail.
- Single-motor operation (one motor run by one inverter) should be performed.
- The wiring length from inverter to motor should be within 30m. (Perform offline auto tuning in the state where wiring work is performed when the wiring length exceeds 30m.)
- Permissible wiring length between inverter and motor differs according to the inverter capacity and setting value of Pr. 72 PWM frequency selection (carrier frequency). Refer to page 14 for the permissible wiring length.

5.3.1 Selection method of Advanced magnetic flux vector control

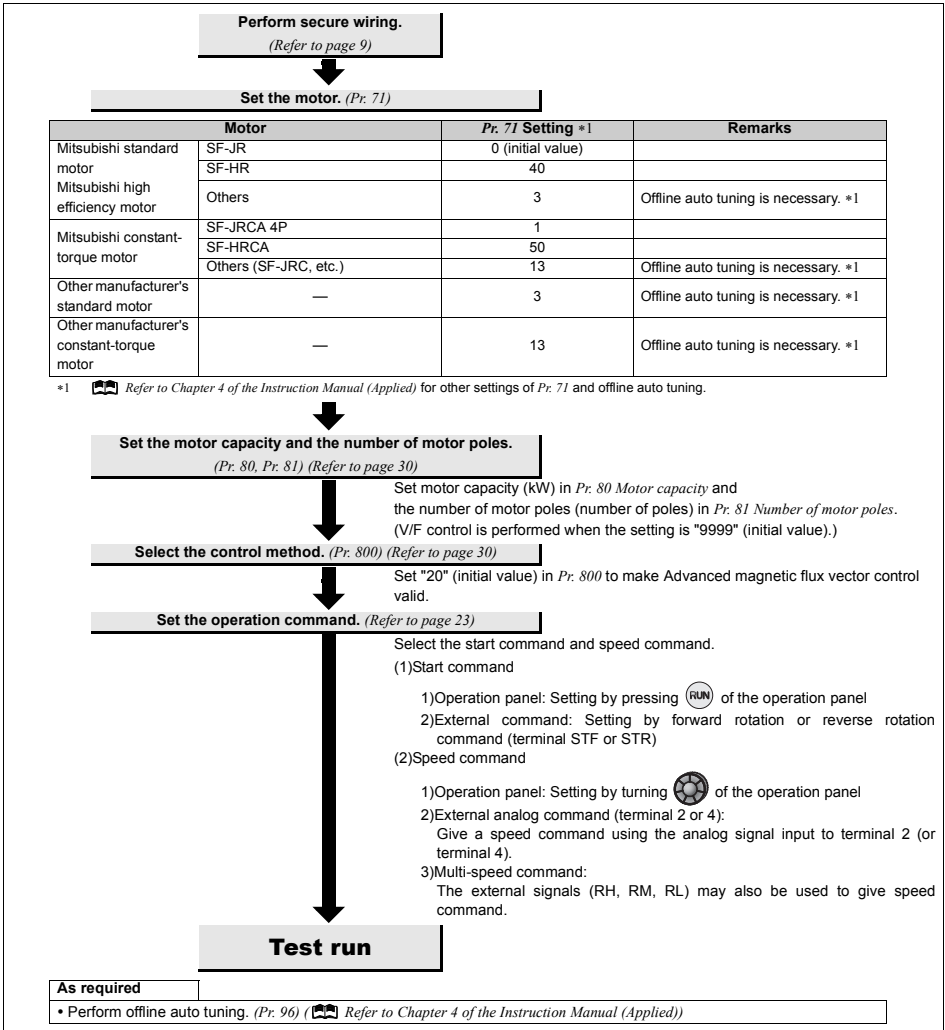

5



NOTE

- Uneven rotation slightly increases as compared to the V/F control. (It is not suitable for machines such as grinding machine and wrapping machine which requires less uneven rotation at low speed.)
- When a surge voltage suppression filter (FR-ASF-H/FR-BMF-H) is connected between the inverter and motor, output torque may decrease.



REMARKS

- Use Pr. 89 to adjust the motor speed fluctuation at load fluctuation. (Refer to Chapter 4 of the Instruction Manual (Applied).)

5.3.2 Selection method of General-purpose magnetic flux vector control

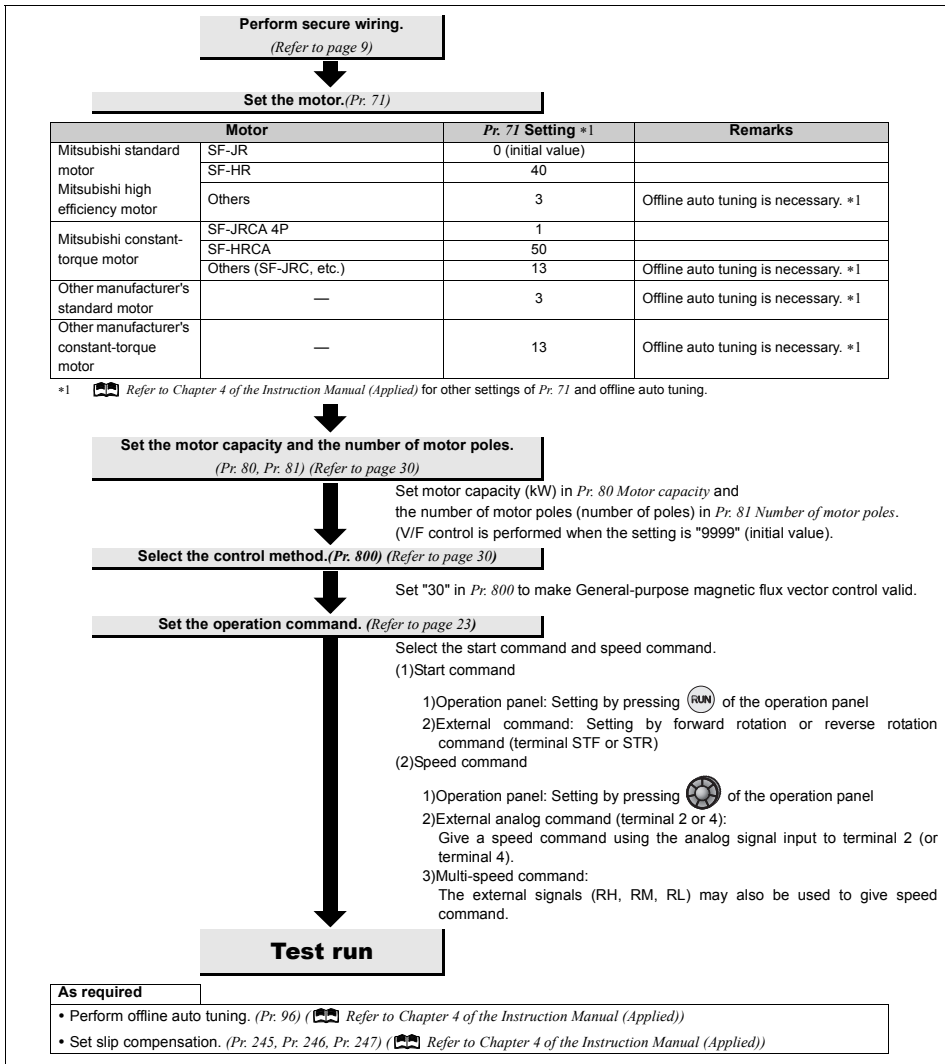

NOTE

- Uneven rotation slightly increases as compared to the V/F control. (It is not suitable for machines such as grinding machine and wrapping machine which requires less uneven rotation at low speed.)
- When a surge voltage suppression filter (FR-ASF-H/FR-BMF-H) is connected between the inverter and motor, output torque may decrease.

6 ENERGY SAVING OPERATION FOR FANS AND PUMPS

Set the following functions to perform energy saving operation for fans and pumps.

(1) Load pattern selection (Pr. 14)

Select the optimum output characteristic (V/F characteristic) that is suitable for the application and load characteristics.

- Set *Pr.14 Load pattern selection* = "1 (for variable-torque load)."
- When the output frequency is equal to or less than the base frequency, the output voltage changes by its square in proportion to the output frequency.

Use this setting to drive a load whose load torque changes in proportion to the square of the speed, such as a fan and a pump.

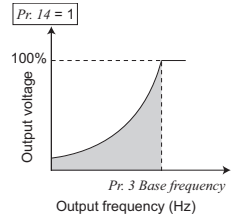

NOTE

- Load pattern selection is available only under V/F control. Load pattern selection is not available under Advanced magnetic flux vector control and General-purpose magnetic flux vector control.

(2) Optimum excitation control (Pr. 60)

Without a detailed parameter setting, the inverter automatically performs energy saving operation.

This operation is optimum for fan and pump applications.

- Set *Pr.60 Energy saving control selection* = "9 (optimum excitation control mode)."
- The Optimum excitation control mode is a control system which controls excitation current to improve the motor efficiency to the maximum and determines output voltage as an energy saving method.



REMARKS

- When the motor capacity is too small as compared to the inverter capacity or two or more motors are connected to one inverter, the energy saving effect is not expected.



NOTE

- When the Optimum excitation control mode is selected, deceleration time may be longer than the setting value. Since overvoltage alarm tends to occur as compared to the constant-torque load characteristics, set a longer deceleration time.
- Optimum excitation control is available only under V/F control. Optimum excitation control is not available under Advanced magnetic flux vector control and General-purpose magnetic flux vector control.
- Optimum excitation control will not be performed during an automatic restart after instantaneous power failure.
- Since output voltage is controlled by Optimum excitation control, output current may slightly increase.

7 PARAMETERS

Simple variable-speed operation can be performed with the inverter in the initial settings. Set the required parameters according to the load and operating conditions. Use the operation panel to set or change a parameter. (Refer to  Chapter 4 of the Instruction Manual (Applied) for the detailed description of parameters.

7.1 Simple mode parameters



POINT

Only simple mode parameter can be displayed using Pr. 160 User group read selection. (All parameters are displayed with the initial setting.) Set Pr. 160 User group read selection as required. (Refer to page 4 for parameter change)

Parameter Number	Name	Unit	Initial Value	Range	Application
0	Torque boost	0.1%	6%/4%/3%/2%*	0 to 30%	Set when you want to increase a starting torque or when the motor with a load will not rotate, resulting in an alarm [OL] and a trip [OC]. * Initial values differ according to the inverter capacity. (0.75K or lower/1.5K to 3.7K/5.5K, 7.5K/11K, 15K)
1	Maximum frequency	0.01Hz	120Hz	0 to 120Hz	Set when the maximum output frequency need to be limited.
2	Minimum frequency	0.01Hz	0Hz	0 to 120Hz	Set when the minimum output frequency need to be limited.
3	Base frequency	0.01Hz	60Hz	0 to 400Hz	Set when the rated motor frequency is 50Hz. Check the motor rating plate.
4	Multi-speed setting (high speed)	0.01Hz	60Hz	0 to 400Hz	Set when changing the preset speed in the parameter with a terminal.
5	Multi-speed setting (middle speed)	0.01Hz	30Hz	0 to 400Hz	
6	Multi-speed setting (low speed)	0.01Hz	10Hz	0 to 400Hz	
7	Acceleration time	0.1s	5s/10s/15s*	0 to 3600s	Acceleration/deceleration time can be set. * Initial values differ according to the inverter capacity. (3.7K or lower/5.5K, 7.5K/11K, 15K)
8	Deceleration time	0.1s	5s/10s/15s*	0 to 3600s	
9	Electronic thermal O/L relay	0.01A	Rated inverter current	0 to 500A	The inverter protects the motor from overheat. Set the rated motor current.
79	Operation mode selection	1	0	0	External/PU switchover mode
				1	Fixed to PU operation mode
				2	Fixed to External operation mode
				3	External/PU combined operation mode 1 (Start command from External, frequency command from PU)
				4	External/PU combined operation mode 2 (Frequency command from External, start command from PU)
				6	Switchover mode
				7	External operation mode (PU operation interlock)
125	Terminal 2 frequency setting gain frequency	0.01Hz	60Hz	0 to 400Hz	Frequency for the maximum value of the potentiometer (5V initial value) can be changed.
126	Terminal 4 frequency setting gain frequency	0.01Hz	60Hz	0 to 400Hz	Frequency for the maximum current input (20mA initial value) can be changed.
160	User group read selection	1	0	0	Display all parameters
				1	Only the parameters registered to the user group can be displayed.
				9999	Only the simple mode parameters can be displayed.
Pr.CL	Parameter clear	1	0	0, 1	Setting "1" returns all parameters except calibration parameters to the initial values.
ALLC	All parameter clear	1	0	0, 1	Setting "1" returns all parameters to the initial values.
Er.CL	Fault history clear	1	0	0, 1	Setting "1" clears eight past faults.
Pr.CH	Initial value change list	—	—	—	Displays and sets the parameters changed from the initial value.

7.2 Parameter list



REMARKS

- indicates simple mode parameters. (initially set to extended mode)
- The parameters surrounded by a black border in the table allow its setting to be changed during operation even if "0" (initial value) is set in Pr. 77 Parameter write selection.

Parameter	Name	Setting Range	Initial Value
● 0	Torque boost	0 to 30%	6/4/3/2% *1
● 1	Maximum frequency	0 to 120Hz	120Hz
● 2	Minimum frequency	0 to 120Hz	0Hz
● 3	Base frequency	0 to 400Hz	60Hz
● 4	Multi-speed setting (high speed)	0 to 400Hz	60Hz
● 5	Multi-speed setting (middle speed)	0 to 400Hz	30Hz
● 6	Multi-speed setting (low speed)	0 to 400Hz	10Hz
● 7	Acceleration time	0 to 3600/ 360s	5/10/15s *2
● 8	Deceleration time	0 to 3600/ 360s	5/10/15s *2
● 9	Electronic thermal O/L relay	0 to 500A	Rated inverter current
10	DC injection brake operation frequency	0 to 120Hz	3Hz
11	DC injection brake operation time	0 to 10s	0.5s
12	DC injection brake operation voltage	0 to 30%	6/4/2% *3
13	Starting frequency	0 to 60Hz	0.5Hz
14	Load pattern selection	0 to 3	0
15	Jog frequency	0 to 400Hz	5Hz
16	Jog acceleration/deceleration time	0 to 3600/ 360s	0.5s
17	MRS input selection	0, 2, 4	0
18	High speed maximum frequency	120 to 400Hz	120Hz
19	Base frequency voltage	0 to 1000V, 8888, 9999	9999
20	Acceleration/deceleration reference frequency	1 to 400Hz	60Hz
21	Acceleration/deceleration time increments	0, 1	0
22	Stall prevention operation level	0 to 200%	150%
23	Stall prevention operation level compensation factor at double speed	0 to 200%, 9999	9999
24	Multi-speed setting (speed 4)	0 to 400Hz, 9999	9999
25	Multi-speed setting (speed 5)	0 to 400Hz, 9999	9999
26	Multi-speed setting (speed 6)	0 to 400Hz, 9999	9999
27	Multi-speed setting (speed 7)	0 to 400Hz, 9999	9999
29	Acceleration/deceleration pattern selection	0, 1, 2	0
30	Regenerative function selection	0, 1, 2	0
31	Frequency jump 1A	0 to 400Hz, 9999	9999
32	Frequency jump 1B	0 to 400Hz, 9999	9999

Parameter	Name	Setting Range	Initial Value
33	Frequency jump 2A	0 to 400Hz, 9999	9999
34	Frequency jump 2B	0 to 400Hz, 9999	9999
35	Frequency jump 3A	0 to 400Hz, 9999	9999
36	Frequency jump 3B	0 to 400Hz, 9999	9999
37	Speed display	0, 0.01 to 9998	0
40	RUN key rotation direction selection	0, 1	0
41	Up-to-frequency sensitivity	0 to 100%	10%
42	Output frequency detection	0 to 400Hz	6Hz
43	Output frequency detection for reverse rotation	0 to 400Hz, 9999	9999
44	Second acceleration/ deceleration time	0 to 3600/ 360s	5/10/15s *2
45	Second deceleration time	0 to 3600/ 360s, 9999	9999
46	Second torque boost	0 to 30%, 9999	9999
47	Second V/F (base frequency)	0 to 400Hz, 9999	9999
48	Second stall prevention operation current	0 to 200%, 9999	9999
51	Second electronic thermal O/L relay	0 to 500A, 9999	9999
52	DU/PU main display data selection	0, 5, 7 to 12, 14, 20, 23 to 25, 52 to 57, 61, 62, 100	0
54	FM terminal function selection	1 to 3, 5, 7 to 12, 14, 21, 24, 52, 53, 61, 62	1
55	Frequency monitoring reference	0 to 400Hz	60Hz
56	Current monitoring reference	0 to 500A	Rated inverter current
57	Restart coasting time	0, 0.1 to 5s, 9999	9999
58	Restart cushion time	0 to 60s	1s
59	Remote function selection	0, 1, 2, 3	0
60	Energy saving control selection	0, 9	0
61	Reference current	0 to 500A, 9999	9999
62	Reference value at acceleration	0 to 200%, 9999	9999
63	Reference value at deceleration	0 to 200%, 9999	9999
65	Retry selection	0 to 5	0
66	Stall prevention operation reduction starting frequency	0 to 400Hz	60Hz
67	Number of retries at fault occurrence	0 to 10, 101 to 110	0

Parameter list

Parameter	Name	Setting Range	Initial Value
68	Retry waiting time	0.1 to 360s	1s
69	Retry count display erase	0	0
70	Special regenerative brake duty	0 to 30%	0%
71	Applied motor	0, 1, 3 to 6, 13 to 16, 23, 24, 40, 43, 44, 50, 53, 54	0
72	PWM frequency selection	0 to 15	1
73	Analog input selection	0, 1, 10, 11	1
74	Input filter time constant	0 to 8	1
75	Reset selection/disconnected PU detection/PU stop selection	0 to 3, 14 to 17	14
77	Parameter write selection	0, 1, 2	0
78	Reverse rotation prevention selection	0, 1, 2	0
◎ 79	Operation mode selection	0, 1, 2, 3, 4, 6, 7	0
80	Motor capacity	0.1 to 15kW, 9999	9999
81	Number of motor poles	2, 4, 6, 8, 10, 9999	9999
82	Motor excitation current	0 to 500A (0 to ****), 9999 *5	9999
83	Rated motor voltage	0 to 1000V	200/400V ^{±4}
84	Rated motor frequency	10 to 120Hz	60Hz
89	Speed control gain (Advanced magnetic flux vector)	0 to 200%, 9999	9999
90	Motor constant (R1)	0 to 50Ω (0 to ****), 9999 *5	9999
91	Motor constant (R2)	0 to 50Ω (0 to ****), 9999 *5	9999
92	Motor constant (L1)	0 to 1000mH (0 to 50Ω, 0 to ****), 9999 *5	9999
93	Motor constant (L2)	0 to 1000mH (0 to 50Ω, 0 to ****), 9999 *5	9999
94	Motor constant (X)	0 to 100% (0 to 500Ω, 0 to ****), 9999 *5	9999
96	Auto tuning setting/status	0, 1, 11, 21	0
117	PU communication station number	0 to 31 (0 to 247)	0
118	PU communication speed	48, 96, 192, 384	192
119	PU communication stop bit length	0, 1, 10, 11	1
120	PU communication parity check	0, 1, 2	2
121	Number of PU communication retries	0 to 10, 9999	1
122	PU communication check time interval	0, 0.1 to 999.8s, 9999	0
123	PU communication waiting time setting	0 to 150ms, 9999	9999
124	PU communication CR/LF selection	0, 1, 2	1
◎ 125	Terminal 2 frequency setting gain frequency	0 to 400Hz	60Hz

Parameter	Name	Setting Range	Initial Value
◎ 126	Terminal 4 frequency setting gain frequency	0 to 400Hz	60Hz
127	PID control automatic switchover frequency	0 to 400Hz, 9999	9999
128	PID action selection	0, 20, 21, 40 to 43, 50, 51, 60, 61	0
129	PID proportional band	0.1 to 1000%, 9999	100%
130	PID integral time	0.1 to 3600s, 9999	1s
131	PID upper limit	0 to 100%, 9999	9999
132	PID lower limit	0 to 100%, 9999	9999
133	PID action set point	0 to 100%, 9999	9999
134	PID differential time	0.01 to 10.00s, 9999	9999
145	PU display language selection	0 to 7	0
146 *7	Built-in potentiometer switching	0, 1	1
147	Acceleration/deceleration time switching frequency	0 to 400Hz, 9999	9999
150	Output current detection level	0 to 200%	150%
151	Output current detection signal delay time	0 to 10s	0s
152	Zero current detection level	0 to 200%	5%
153	Zero current detection time	0 to 1s	0.5s
156	Stall prevention operation selection	0 to 31, 100, 101	0
157	OL signal output timer	0 to 25s, 9999	0s
◎ 160	User group read selection	0, 1, 9999	0
161	Frequency setting/key lock operation selection	0, 1, 10, 11	0
162	Automatic restart after instantaneous power failure selection	0, 1, 10, 11	1
165	Stall prevention operation level for restart	0 to 200%	150%
168	Parameter for manufacturer setting. Do not set.		
169			
170	Watt-hour meter clear	0, 10, 9999	9999
171	Operation hour meter clear	0, 9999	9999
172	User group registered display/batch clear	9999, (0 to 16)	0
173	User group registration	0 to 999, 9999	9999
174	User group clear	0 to 999, 9999	9999
178	STF terminal function selection	0 to 5, 7, 8, 10, 12, 14 to 16, 18, 24, 25, 60, 62, 65 to 67, 9999	60
179	STR terminal function selection	0 to 5, 7, 8, 10, 12, 14 to 16, 18, 24, 25, 61, 62, 65 to 67, 9999	61

Parameter	Name	Setting Range	Initial Value
180	RL terminal function selection		0
181	RM terminal function selection	0 to 5, 7, 8, 10, 12,	1
182	RH terminal function selection	14 to 16, 18, 24, 25,	2
183 *10	MRS terminal function selection	62, 65 to 67, 9999	24
184	RES terminal function selection		62
190	RUN terminal function selection	0, 1, 3, 4, 7, 8, 11 to 16, 20, 25, 26, 46, 47, 64, 68 *6, 80, 81, 90, 91, 93, 95, 96, 98, 99, 100, 101, 103, 104, 107, 108, 111 to 116, 120, 125, 126, 146, 147, 164, 168 *6, 180, 181, 190, 191, 193, 195, 196, 198, 199, 9999	0
191	FU terminal function selection		4
192	A,B,C terminal function selection	0, 1, 3, 4, 7, 8, 11 to 16, 20, 25, 26, 46, 47, 64, 68 *6, 80, 81, 90, 91, 95, 96, 98, 99, 100, 101, 103, 104, 107, 108, 111 to 116, 120, 125, 126, 146, 147, 164, 168 *6, 180, 181, 190, 191, 195, 196, 198, 199, 9999	99
232	Multi-speed setting (speed 8)	0 to 400Hz, 9999	9999
233	Multi-speed setting (speed 9)	0 to 400Hz, 9999	9999
234	Multi-speed setting (speed 10)	0 to 400Hz, 9999	9999
235	Multi-speed setting (speed 11)	0 to 400Hz, 9999	9999
236	Multi-speed setting (speed 12)	0 to 400Hz, 9999	9999
237	Multi-speed setting (speed 13)	0 to 400Hz, 9999	9999
238	Multi-speed setting (speed 14)	0 to 400Hz, 9999	9999
239	Multi-speed setting (speed 15)	0 to 400Hz, 9999	9999
240	Soft-PWM operation selection	0, 1	1
241	Analog input display unit switchover	0, 1	0
244	Cooling fan operation selection	0, 1	1
245	Rated slip	0 to 50%, 9999	9999
246	Slip compensation time constant	0.01 to 10s	0.5s

Parameter	Name	Setting Range	Initial Value
247	Constant-power range slip compensation selection	0, 9999	9999
249	Earth (ground) fault detection at start	0, 1	0
250	Stop selection	0 to 100s, 1000 to 1100s, 8888, 9999	9999
251	Output phase loss protection selection	0, 1	1
255	Life alarm status display	(0 to 15)	0
256	Inrush current limit circuit life display	(0 to 100%)	100%
257	Control circuit capacitor life display	(0 to 100%)	100%
258	Main circuit capacitor life display	(0 to 100%)	100%
259	Main circuit capacitor life measuring	0, 1 (2, 3, 8, 9)	0
261	Power failure stop selection	0, 1, 2	0
267	Terminal 4 input selection	0, 1, 2	0
268	Monitor decimal digits selection	0, 1, 9999	9999
269	Parameter for manufacturer setting. Do not set.		
270	Stop-on contact control selection	0, 1	0
275	Stop-on contact excitation current low-speed multiplying factor	0 to 300%, 9999	9999
276	PWM carrier frequency at stop-on contact	0 to 9, 9999	9999
277	Stall prevention operation current switchover	0, 1	0
278	Brake opening frequency	0 to 30Hz	3Hz
279	Brake opening current	0 to 200%	130%
280	Brake opening current detection time	0 to 2s	0.3s
281	Brake operation time at start	0 to 5s	0.3s
282	Brake operation frequency	0 to 30Hz	6Hz
283	Brake operation time at stop	0 to 5s	0.3s
286	Droop gain	0 to 100%	0%
287	Droop filter time constant	0 to 1s	0.3s
292	Automatic acceleration/ deceleration	0, 1, 7, 8, 11	0
293	Acceleration/deceleration separate selection	0 to 2	0
295	Magnitude of frequency change setting	0, 0.01, 0.1, 1, 10	0
296	Password lock level	0 to 6, 99, 100 to 106, 199, 9999	9999
297	Password lock/unlock	(0 to 5), 1000 to 9998, 9999	9999
298	Frequency search gain	0 to 32767, 9999	9999
299	Rotation direction detection selection at restarting	0, 1, 9999	0
338	Communication operation command source	0, 1	0
339	Communication speed command source	0, 1, 2	0
340	Communication startup mode selection	0, 1, 10	0
342	Communication EEPROM write selection	0, 1	0
343	Communication error count	—	0

Parameter	Name	Setting Range	Initial Value
450	Second applied motor	0, 1, 9999	9999
495	Remote output selection	0, 1, 10, 11	0
496	Remote output data 1	0 to 4095	0
497	Remote output data 2	0 to 4095	0
502	Stop mode selection at communication error	0, 1, 2, 3	0
503	Maintenance timer	0 (1 to 9998)	0
504	Maintenance timer alarm output set time	0 to 9998, 9999	9999
547	USB communication station number	0 to 31	0
548	USB communication check time interval	0 to 999.8s, 9999	9999
549	Protocol selection	0, 1	0
550	NET mode operation command source selection	0, 2, 9999	9999
551	PU mode operation command source selection	2 to 4, 9999	9999
555	Current average time	0.1 to 1.0s	1s
556	Data output mask time	0 to 20s	0s
557	Current average value monitor signal output reference current	0 to 500A	Rated inverter current
563	Energization time carrying-over times	(0 to 65535)	0
564	Operating time carrying-over times	(0 to 65535)	0
571	Holding time at a start	0 to 10s, 9999	9999
611	Acceleration time at a restart	0 to 3600s, 9999	9999
653	Speed smoothing control	0 to 200%	0
665	Regeneration avoidance frequency gain	0 to 200%	100
800	Control method selection	20, 30	20
859	Torque current	0 to 500A (0 to ****), 9999 *5	9999
872 *9	Input phase loss protection selection	0, 1	1
882	Regeneration avoidance operation selection	0, 1, 2	0
883	Regeneration avoidance operation level	300 to 800V	400VDC/ 780VDC *4
885	Regeneration avoidance compensation frequency limit value	0 to 10Hz, 9999	6Hz
886	Regeneration avoidance voltage gain	0 to 200%	100%
888	Free parameter 1	0 to 9999	9999
889	Free parameter 2	0 to 9999	9999
C0 (900) *8	FM terminal calibration	—	—
C2 (902) *8	Terminal 2 frequency setting bias frequency	0 to 400Hz	0Hz
C3 (902) *8	Terminal 2 frequency setting bias	0 to 300%	0%
125 (903) *8	Terminal 2 frequency setting gain frequency	0 to 400Hz	60Hz
C4 (903) *8	Terminal 2 frequency setting gain	0 to 300%	100%
C5 (904) *8	Terminal 4 frequency setting bias frequency	0 to 400Hz	0Hz
C6 (904) *8	Terminal 4 frequency setting bias	0 to 300%	20%

Parameter	Name	Setting Range	Initial Value
126 (905) *8	Terminal 4 frequency setting gain frequency	0 to 400Hz	60Hz
C7 (905) *8	Terminal 4 frequency setting gain	0 to 300%	100%
C22 (922) *7,*8	Frequency setting voltage bias frequency (built-in potentiometer)	0 to 400Hz	0
C23 (922) *7,*8	Frequency setting voltage bias (built-in potentiometer)	0 to 300%	0
C24 (923) *7,*8	Frequency setting voltage gain frequency (built-in potentiometer)	0 to 400Hz	60Hz
C25 (923) *7,*8	Frequency setting voltage gain (built-in potentiometer)	0 to 300%	100%
990	PU buzzer control	0, 1	1
991	PU contrast adjustment	0 to 63	58
Pr.CL	Parameter clear	0, 1	0
ALLC	All parameter clear	0, 1	0
Er.CL	Faults history clear	0, 1	0
Pr.CH	Initial value change list	—	—

- *1 Differ according to capacities.
6%: 0.75K or lower
4%: 1.5K to 3.7K
3%: 5.5K, 7.5K
2%: 11K, 15K
- *2 Differ according to capacities.
5s: 3.7K or lower
10s: 5.5K, 7.5K
15s: 11K, 15K
- *3 Differ according to capacities.
6%: 0.1K, 0.2K
4%: 0.4K to 7.5K
2%: 11K, 15K
- *4 The initial value differs according to the voltage class. (200V class/400V class)
- *5 The range differs according to the Pr. 7/ setting.
- *6 The setting values "68 and 168" are only available with FR-E7DS mounted.
- *7 Set this parameter when calibrating the operation panel built-in potentiometer for the FR-E500 series operation panel (PA02) connected with cable.
- *8 The parameter number in parentheses is the one for use with the operation panel (PA02) for the FR-E500 series or parameter unit (FR-PU04/FR-PU07).
- *9 Available only for the three-phase power input model.
- *10 This setting is active only during the communication operation.

8 TROUBLESHOOTING

When a fault occurs in the inverter, the inverter trips and the PU display automatically changes to one of the following fault or alarm indications.

If the fault does not correspond to any of the following faults or if you have any other problem, please contact your sales representative.

- Retention of fault output signal .. When the magnetic contactor (MC) provided on the input side of the inverter is opened when a fault occurs, the inverter's control power will be lost and the fault output will not be held.
- Fault or alarm indication.....When a fault or alarm occurs, the operation panel display automatically switches to the fault or alarm indication.
- Resetting method.....When a fault occurs, the inverter output is kept stopped. Unless reset, therefore, the inverter cannot restart. (Refer to page 39)
- When any fault occurs, take the appropriate corrective action, then reset the inverter, and resume operation. Not doing so may lead to the inverter fault and damage.

Inverter fault or alarm indications are roughly categorized as below.

- (1) Error message
A message regarding operational fault and setting fault by the operation panel and parameter unit (FR-PU04 /FR-PU07) is displayed. The inverter does not trip.
- (2) Warning
The inverter does not trip even when a warning is displayed. However, failure to take appropriate measures will lead to a fault.
- (3) Alarm
The inverter does not trip. You can also output an alarm signal by making parameter setting.
- (4) Fault
When a fault occurs, the inverter trips and a fault signal is output.

REMARKS

- For the details of fault displays and other malfunctions, also refer to the Instruction Manual (Applied).
- Past eight faults can be displayed using the setting dial. (Refer to page 3 for the operation.)

8.1 Reset method of protective function

The inverter can be reset by performing any of the following operations. Note that the internal thermal integrated value of the electronic thermal relay function and the number of retries are cleared (erased) by resetting the inverter. Inverter recovers about 1s after the reset is released.

Operation 1: Using the operation panel, press  to reset the inverter.
(This may only be performed when a fault occurs (Refer to page 40 for fault.))

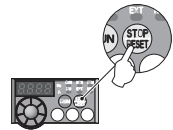

Operation 2: Turn ON the reset signal (RES) for more than 0.1s. (If the RES signal is kept ON, "Err." appears (flickers) to indicate that the inverter is in a reset status.)

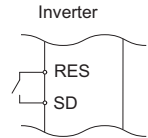

Operation 3: Switch power OFF once. After the indicator of the operation panel turns OFF, switch it ON again.

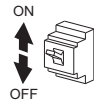

REMARKS

- Use the operation 1 or 2 to reset when using the 24V external power supply. (Inverter with FR-E7DS mounted.)

NOTE

- OFF status of the start signal must be confirmed before resetting the inverter fault. Resetting inverter fault with the start signal ON restarts the motor suddenly.

8.2 List of fault displays

When a fault occurs in the inverter, the inverter trips and the PU display automatically changes to one of the following fault or alarm indications.

The error message shows an operational error. The inverter output is not shut off.

Warnings are messages given before faults occur. The inverter output is not shut off.

Alarms warn the operator of failures with output signals. The inverter output is not shut off.

When faults occur, the protective functions are activated to inverter trip and output the fault signals.

Function Name	Description	Corrective action	Display	
Error message	Operation panel lock	Operation has been attempted during the operation panel lock. Press (MODE) for 2s to release the lock.	HOL d	
	Password locked	Reading/writing of a password-restricted parameter has been attempted. Enter the password in Pr. 297 Password lock/unlock to unlock the password function before operating.	L O C d	
	Write disable error	<ul style="list-style-type: none"> Parameter setting has been attempted although parameter writing is set to be disabled. Overlapping range has been set for the frequency jump. PU and the inverter cannot make normal communication. 	<ul style="list-style-type: none"> Check the setting of Pr. 77 Parameter write selection. Check the settings of Pr. 31 to Pr. 36 (frequency jump). Check the connection of PU and the inverter. 	Er 1
	Write error during operation	Parameter writing has been attempted while a value other than "2" is set in Pr. 77 Parameter write selection and the STF (STR) is ON. Set "2" in Pr. 77 Parameter write selection. After stopping the operation, set parameters.	Er 2	
	Calibration error	Analog input bias and gain calibration values have been set too close. Check the settings of calibration parameters C3, C4, C6 and C7 (calibration functions).	Er 3	
	Mode designation error	<ul style="list-style-type: none"> Parameter setting has been attempted in the External or NET operation mode when Pr.77 Parameter write selection is not "2." Parameter writing has been attempted when the command source is not at the operation panel. 	<ul style="list-style-type: none"> After setting the operation mode to the "PU operation mode," set parameters. Set "2" in Pr.77 Parameter write selection. Disconnect the USB cable from the USB connector and the parameter unit (FR-PU04/FR-PU07) from the PU connector, then set Pr. 551 PU mode operation command source selection = "9999 (initial setting)." Set Pr. 551 PU mode operation command source selection = "4." 	Er 4
	Inverter reset	The reset signal (RES signal) is ON. (Inverter output is shutoff). Turn OFF the reset command.	Er r.	
Warning	Stall prevention (overcurrent)	The overcurrent stall prevention has been activated. <ul style="list-style-type: none"> Increase or decrease the Pr. 0 Torque boost setting by 1% and check the motor status. Set the acceleration/deceleration time longer. Reduce the load. Try Advanced magnetic flux vector control or General-purpose magnetic flux vector control. Check the peripheral devices for faults. Adjust the Pr. 13 Starting frequency setting. Change the Pr. 14 Load pattern selection setting. Set the stall prevention operation current in Pr. 22 Stall prevention operation level. (The acceleration/deceleration time may change.) Increase the stall prevention operation level with Pr. 22 Stall prevention operation level, or disable stall prevention with Pr. 156 Stall prevention operation selection. (Operation at OL occurrence can be selected using Pr. 156 Stall prevention operation selection.) 	OL	
	Stall prevention (overvoltage)	The overvoltage stall prevention function has been activated. (This warning is also output during the regeneration avoidance operation.) Set the deceleration time longer.	oL	
	Regenerative brake prealarm #2	The regenerative brake duty has reached 85% of the Pr. 70 Special regenerative brake duty setting or higher. Set the deceleration time longer. Check the Pr.30 Regenerative function selection and Pr. 70 Special regenerative brake duty settings.	r b	
	Electronic thermal relay function prealarm #1	The cumulative value of the electronic thermal O/L relay has reached 85% of the Pr. 9 Electronic thermal O/L relay setting or higher. Reduce the load and frequency of operation. Set an appropriate value in Pr. 9 Electronic thermal O/L relay.	F H	
	PU stop	(STOP) on the operation panel has been pressed during the External operation. Turn the start signal OFF and release with (PU EXT) .	P S	
	Maintenance signal output #2	The cumulative energization time has exceeded the maintenance output timer set value. Setting "0" in Pr. 503 Maintenance timer erases the signal.	M F	
Undervoltage	The voltage at the main circuit power has been lowered. Investigate the devices on the power supply line such as the power supply itself.	U u		

Function Name	Description	Corrective action	Display	
Warning	Safety stop	Safety stop function is activated (during output shutoff).	<ul style="list-style-type: none"> When not using the safety stop function, short across terminals S1 and PC and across S2 and PC with shorting wire for the inverter to run. If S_R is indicated when across S1 and PC and across S2 and PC are both shorted while using the safety stop function (drive enabled), internal failure might be the cause. Check the wiring of terminals S1, S2 and PC and contact your sales representative if the wiring has no fault. 	S_R
	24V external power supply operation	The main circuit power supply is not supplied and the 24V external power is supplied while FR-E7DS is mounted. (The display flickers.)	<ul style="list-style-type: none"> Turn ON the power supply for the inverter (main circuit). If E_U appears by turning ON the power supply of the inverter (main circuit) while the external 24V power is supplied, check the power supply (for the main circuit). Check if the jumper is installed securely between terminal P/+ and P1. 	E_U
Alarm	Fan alarm	The cooling fan is at a standstill although it is required to be operated. The cooling fan speed has decelerated.	Check for fan failure. Please contact your sales representative.	F_n
Fault	Overcurrent trip during acceleration	Overcurrent has occurred during acceleration.	<ul style="list-style-type: none"> Set the acceleration time longer. (Shorten the downward acceleration time in vertical lift application.) If "E.OC1" always appears at start, disconnect the motor once and restart the inverter. If "E.OC1" still appears, the inverter may be faulty. Contact your sales representative. Check the wiring for output short circuit and ground fault. When the rated motor frequency is 50Hz, set the <i>Pr. 3 Base frequency</i> to 50Hz. Lower the stall prevention operation level. Activate the stall prevention operation and the fast-response current limit operation. (<i>Pr.156</i>) For the operation with frequent regenerative driving, set the base voltage (rated motor voltage, etc.) in <i>Pr. 19 Base frequency voltage</i>. If the motor is coasting, stop the motor, then input a start command. Alternatively, use the automatic restart after instantaneous power failure/flying start function. 	$E.OC1$
	Overcurrent trip during constant speed	Overcurrent has occurred during constant speed operation.	<ul style="list-style-type: none"> Keep the load stable. Check the wiring to avoid output short circuit or ground fault. Lower the stall prevention operation level. Activate the stall prevention operation and the fast-response current limit operation. (<i>Pr.156</i>) If the motor is coasting, stop the motor, then input a start command. Alternatively, use the automatic restart after instantaneous power failure/flying start function. 	$E.OC2$
	Overcurrent trip during deceleration or stop	Overcurrent has occurred during deceleration or at a stop.	<ul style="list-style-type: none"> Set the deceleration time longer. Check the wiring to avoid output short circuit or ground fault. Check if the mechanical brake is set to be activated too early. Lower the stall prevention operation level. Activate the stall prevention operation and the fast-response current limit operation. (<i>Pr.156</i>) If the motor is coasting, stop the motor, then input a start command. Alternatively, use the automatic restart after instantaneous power failure/flying start function. 	$E.OC3$
	Regenerative overvoltage trip during acceleration	Overvoltage has occurred during acceleration.	<ul style="list-style-type: none"> Set the acceleration time shorter. Use the regeneration avoidance function (<i>Pr. 882, Pr. 883, Pr.885, Pr.886</i>) Set the <i>Pr. 22 Stall prevention operation level</i> correctly. 	$E.OV1$
	Regenerative overvoltage trip during constant speed	Overvoltage has occurred during constant speed operation.	<ul style="list-style-type: none"> Keep the load stable. Use the regeneration avoidance function (<i>Pr. 882, Pr. 883, Pr.885, Pr.886</i>). Use the brake resistor, brake unit or power regeneration common converter (FR-CV) as required. Set the <i>Pr. 22 Stall prevention operation level</i> correctly. 	$E.OV2$
	Regenerative overvoltage trip during deceleration or stop	Overvoltage has occurred during deceleration or at a stop.	<ul style="list-style-type: none"> Set the deceleration time longer. (Set the deceleration time which matches the moment of inertia of the load.) Make the brake cycle longer. Use the regeneration avoidance function (<i>Pr. 882, Pr. 883, Pr.885, Pr.886</i>) Use the brake resistor, brake unit or power regeneration common converter (FR-CV) as required. 	$E.OV3$

Function Name	Description	Corrective action	Display
Inverter overload trip (electronic thermal O/L relay function) *1	The electronic thermal relay function for inverter element protection has been activated.	<ul style="list-style-type: none"> Set the acceleration time longer. Adjust the <i>Pr. 0 Torque boost</i> setting. Set the <i>Pr. 14 Load pattern selection</i> setting according to the load pattern of the using machine. Reduce the load. Set the surrounding air temperature to within the specifications. 	E ₁ H ₁ F
Motor overload trip (electronic thermal O/L relay function) *1	The electronic thermal relay function for motor protection has been activated.	<ul style="list-style-type: none"> Reduce the load. For a constant-torque motor, set the constant-torque motor in <i>Pr. 71 Applied motor</i>. Set the stall prevention operation level accordingly. 	E ₁ H ₁ D
Heatsink overheat	The heatsink has overheated.	<ul style="list-style-type: none"> Set the surrounding air temperature to within the specifications. Clean the heatsink. Replace the cooling fan. 	E ₁ F ₁ o
Input phase loss *2	One of the three phases on the inverter input side has been lost. It may also appear if phase-to-phase voltage of the three-phase power input has become largely unbalanced.	<ul style="list-style-type: none"> Wire the cables properly. Repair a break portion in the cable. Check the <i>Pr. 872 Input phase loss protection selection</i> setting. Set <i>Pr. 872 Input phase loss protection selection = "0"</i> (without input phase loss protection) when three-phase input voltage is largely unbalanced. 	E ₁ L ₁ F
Stall prevention stop	The output frequency has dropped to 1Hz as a result of deceleration due to the excess motor load.	Reduce the load. (Check the <i>Pr. 22 Stall prevention operation level</i> setting.)	E ₁ O ₁ L ₁ F
Brake transistor alarm detection	A fault has occurred in the brake circuit, such as a brake transistor breakage. (In this case, the inverter must be powered off immediately.)	Replace the inverter.	E ₁ bE
Output side earth (ground) fault overcurrent at start *2	An earth (ground) fault has occurred on the inverter's output side (detected only at a start).	Remedy the ground fault portion.	E ₁ GF
Output phase loss	One of the three phases (U, V, W) on the inverter's output side (load side) has been lost during inverter operation.	<ul style="list-style-type: none"> Wire the cables properly. If the motor capacity is smaller than the inverter capacity, choose the inverter and motor capacities that match. If the motor is coasting, stop the motor, then input a start command. Alternatively, use the automatic restart after instantaneous power failure/flying start function. 	E ₁ L ₁ F
External thermal relay operation *2	The external thermal relay connected to the OH signal has been activated.	<ul style="list-style-type: none"> Reduce the load and operate less frequently. Even if the relay contacts are reset automatically, the inverter will not restart unless it is reset. 	E ₁ O ₁ H ₁ F
Option fault	A communication option has been mounted while <i>Pr.296 Password lock level = "0 or 100."</i>	<ul style="list-style-type: none"> To apply the password lock when installing a communication option, set <i>Pr.296 Password lock level = "0, 100."</i> If the problem still persists after taking the above measure, contact your sales representative. 	E ₁ O ₁ P ₁ F
Communication option fault	A communication error has occurred on the communication line of the communication option.	<ul style="list-style-type: none"> Check the settings of the option functions. Connect the built-in option securely. Check the connections of the communication cables. Connect terminating resistors correctly. 	E ₁ O ₁ P ₁ I
Option fault	A fault, such as a contact fault, has occurred at the contactor of the inverter or the plug-in option. The setting of the switch on the plug-in option, which is for manufacturer setting, has been changed.	<ul style="list-style-type: none"> Connect the plug-in option securely. Take measures against noises if there are devices producing excess electrical noises around the inverter. If the situation does not improve after taking the above measure, please contact your sales representative. Set the switch on the plug-in option, which is for manufacturer setting, back to the initial setting. (Refer to the Instruction Manual of each option.) 	E ₁ o
Parameter storage device fault	Operation of the component where parameters are stored (control circuit board) has become abnormal.	Please contact your sales representative. When performing parameter writing frequently for communication purposes, set "1" in <i>Pr. 342 Communication EEPROM write selection</i> to enable RAM write. Note that powering OFF returns the inverter to the status before RAM write.	E ₁ PE
Internal board fault	The control circuit board and the main circuit board do not match.	Please contact your sales representative. (For parts replacement, consult the nearest Mitsubishi FA Center.)	E ₁ PE2
PU disconnection	<ul style="list-style-type: none"> A communication error has occurred between the PU and the inverter. The communication interval has exceeded the permissible time period during RS-485 communication via the PU connector. The number of communication errors has exceeded the number of retries. 	<ul style="list-style-type: none"> Connect the parameter unit cable securely. Check the communication data and communication settings. Increase the <i>Pr. 122 PU communication check time interval</i> setting, or set "9999" (no communication check). 	E ₁ P ₁ UE
Retry count excess *2	Operation restart within the set number of retries has failed.	Eliminate the cause of the error preceding this error indication.	E ₁ rE ₁ F

Function Name	Description	Corrective action	Display	
Fault	CPU fault	An error has occurred in the CPU and in the peripheral circuits.	<ul style="list-style-type: none"> Take measures against noises if there are devices producing excess electrical noises around the inverter. Check the connection between the terminals PC and SD. (E6/E7) If the situation does not improve after taking the above measure, please contact your sales representative. 	E: 5/ E: 6/ E: 7/ E: CPU
	Brake sequence fault *2	A sequence error has occurred while the brake sequence function (Pr.278 to Pr.283) is valid.	Check the parameter setting and check the wiring.	E:Ab4 to E:Ab7
	Inrush current limit circuit fault	The resistor of the inrush current limit circuit has overheated.	Configure a circuit where frequent power ON/OFF is not repeated. If the situation does not improve after taking the above measure, please contact your sales representative.	E:DH
	Analog input fault	A voltage (current) has been input to terminal 4 when the setting in Pr. 267 Terminal 4 input selection and the setting of voltage/current input switch are different.	Give a frequency command by a current input or set Pr.267 Terminal 4 input selection, and set the voltage/current input switch to voltage input.	E:AI E
	USB communication fault	The communication has been broken for Pr. 548 USB communication check time interval.	<ul style="list-style-type: none"> Check the Pr.548 USB communication check time interval setting. Check the USB communication cable. Increase the Pr.548 USB communication check time interval setting, or set "9999." 	E:USb
	Safety circuit fault	The safety circuit fault has occurred, or either the contact between terminals S1 and PC or the contact between terminals S2 and PC has opened.	<ul style="list-style-type: none"> When not using the safety stop function, short across terminals S1 and PC and across S2 and PC with shorting wire. When using the safety stop function, check that wiring of terminal S1, S2 and PC is correct and the safety stop input signal source such as safety relay module is operating properly. Refer to the Safety stop function instruction manual (BCN-211508-004) for causes and countermeasures. (Refer to the front cover for how to obtain the manual.) 	E:SRF
Internal circuit fault	An internal circuit fault has occurred.	Please contact your sales representative.	E: 13	

*1 Resetting the inverter initializes the internal cumulative heat value of the electronic thermal relay function.

*2 This protective function is not available in the initial status.

8.3 Check first when you have a trouble

Description	Countermeasure
Motor does not start.	Check start and frequency command sources and enter a start command (STF, etc.) and a frequency command.
Motor or machine is making abnormal acoustic noise.	Take EMC measures if a steady operation cannot be performed due to EMI. Alternatively, set the Pr.74 Input filter time constant setting higher.
Inverter generates abnormal noise.	Install a fan cover correctly.
Motor generates heat abnormally.	Clean the motor fan. Improve the environment.
Motor rotates in the opposite direction.	Connect phase sequence of the output cables (terminal U, V, W) to the motor correctly. Alternatively, check the connection of the start signal. (STF: forward rotation, STR: reverse rotation)
Speed greatly differs from the setting.	Check the settings of Pr.1 Maximum frequency, Pr.2 Minimum frequency, Pr.18 High speed maximum frequency, and calibration parameters C2 to C7.
Acceleration/deceleration is not smooth.	Reduce the load. Alternatively, increase the acceleration/deceleration time.
Speed varies during operation.	Check the frequency setting signals. If the load fluctuates, select Advanced magnetic flux vector control or General-purpose magnetic flux vector control.
Operation mode is not changed properly.	Turn OFF the start signal (STF or STR). Check if Pr.79 Operation mode selection is set appropriately.
Operation panel display is not operating.	Check the wiring and the installation.
Motor current is large.	Increase/decrease the Pr.0 Torque boost setting value by 0.5% increments so that stall prevention does not occur. Set the rated motor frequency to Pr.3 Base frequency.
Speed does not accelerate.	Check the settings of Pr.1 Maximum frequency, Pr.2 Minimum frequency, and calibration parameters C2 to C7. To operate at 120Hz or higher, set Pr.18 High speed maximum frequency.
Unable to write parameter setting.	Check Pr.77 Parameter write selection setting.

* For further information on troubleshooting, refer to the  Instruction Manual (Applied).

9 PRECAUTIONS FOR MAINTENANCE AND INSPECTION

The inverter is a static unit mainly consisting of semiconductor devices. Daily inspection must be performed to prevent any fault from occurring due to the adverse effects of the operating environment, such as temperature, humidity, dust, dirt and vibration, changes in the parts with time, service life, and other factors.



REMARKS

• For maintenance/inspection and parts life, also refer to the Instruction Manual (Applied).

●Precautions for maintenance and inspection

For some short time after the power is switched OFF, a high voltage remains in the smoothing capacitor. When accessing the inverter for inspection, wait for at least 10 minutes after the power supply has been switched OFF, and then make sure that the voltage across the main circuit terminals P/+ and N/- of the inverter is not more than 30VDC using a tester, etc.

If "EV" is displayed on the operation panel with FR-E7DS mounted, turn off the 24V external power supply before an inspection.

9.1 Inspection items

Area of Inspection	Inspection Item	Description	Interval		Corrective Action at Alarm Occurrence	Customer's Check	
			Daily	Periodic *2			
General	Surrounding environment	Check the surrounding air temperature, humidity, dirt, corrosive gas, oil mist, etc.	○		Improve environment		
	Overall unit	Check for unusual vibration and noise.	○		Check alarm location and retighten		
	Power supply voltage	Check that the main circuit voltages are normal. *1	○		Inspect the power supply		
Main circuit	General	(1) Check with megger (across main circuit terminals and earth (ground) terminal).		○	Contact the manufacturer		
		(2) Check for loose screws and bolts.		○	Retighten		
		(3) Check for overheat traces on the parts.		○	Contact the manufacturer		
		(4) Check for stain.		○	Clean		
	Conductors, cables	(1) Check conductors for distortion.		○	Contact the manufacturer		
		(2) Check cable sheaths for breakage and deterioration (crack, discoloration, etc.).		○	Contact the manufacturer		
Terminal block	Check for damage.		○	Stop the device and contact the manufacturer.			
Smoothing aluminum electrolytic capacitor	(1) Check for liquid leakage.		○	Contact the manufacturer			
	(2) Check for safety valve projection and bulge.		○	Contact the manufacturer			
Relay	(3) Visual check and judge by the life check of the main circuit capacitor (Refer to Chapter 4 of the Instruction Manual (Applied).)		○				
	Check that the operation is normal and no chatter is heard.		○	Contact the manufacturer			
Control circuit, Protective circuit	Operation check	(1) Check that the output voltages across phases with the inverter operated alone is balanced.		○	Contact the manufacturer		
		(2) Check that no fault is found in protective and display circuits in a sequence protective operation test.		○	Contact the manufacturer		
	Parts check	Overall	(1) Check for unusual odor and discoloration.		○	Stop the device and contact the manufacturer.	
		(2) Check for serious rust development.		○	Contact the manufacturer		
Aluminum electrolytic capacitor	(1) Check for liquid leakage in a capacitor and deformation trace.		○	Contact the manufacturer			
	(2) Visual check and judge by the life check of the main circuit capacitor (Refer to Chapter 4 of the Instruction Manual (Applied).)		○				
Cooling system	Cooling fan	(1) Check for unusual vibration and noise.	○		Replace the fan		
		(2) Check for loose screws and bolts.		○	Fix with the fan cover fixing screws		
		(3) Check for stain.		○	Clean		
Heatsink	(1) Check for clogging.		○	Clean			
	(2) Check for stain.		○	Clean			
Display	Indication	(1) Check that display is normal.	○		Contact the manufacturer		
	(2) Check for stain.		○	Clean			
Meter	Check that reading is normal.		○		Stop the device and contact the manufacturer.		
	Operation check	Check for vibration and abnormal increase in operation noise.	○		Stop the device and contact the manufacturer.		

*1 It is recommended to install a device to monitor voltage for checking the power supply voltage to the inverter.

*2 One to two years of periodic inspection cycle is recommended. However, it differs according to the installation environment. For a periodic inspection, contact your sales representative.

When using the safety stop function, periodic inspection is required to confirm that safety function of the safety system operates correctly.

For more details, refer to the Safety stop function instruction manual (BCN-A211508-004). (Refer to the front cover for how to obtain the manual.)

9.2 Replacement of parts

The inverter consists of many electronic parts such as semiconductor devices.

The following parts may deteriorate with age because of their structures or physical characteristics, leading to reduced performance or fault of the inverter. For preventive maintenance, the parts must be replaced periodically.

Use the life check function as a guidance of parts replacement.

Part Name	Estimated lifespan *1	Description
Cooling fan	10 years	Replace (as required)
Main circuit smoothing capacitor	10 years *2	Replace (as required)
On-board smoothing capacitor	10 years	Replace the board (as required)
Relays	—	as required

*1 Estimated lifespan for when the yearly average surrounding air temperature is 40°C (without corrosive gas, flammable gas, oil mist, dust and dirt etc.)

*2 Output current: 80% of the inverter rated current



NOTE

For parts replacement, consult the nearest Mitsubishi FA Center.

10 SPECIFICATIONS

10.1 Rating

● Three-phase 200V power supply

Model FR-E720-□KSC		0.1	0.2	0.4	0.75	1.5	2.2	3.7	5.5	7.5	11	15	
Applicable motor capacity (kW) *1		0.1	0.2	0.4	0.75	1.5	2.2	3.7	5.5	7.5	11	15	
Output	Rated capacity (kVA) *2	0.3	0.6	1.2	2.0	3.2	4.4	7.0	9.5	13.1	18.7	23.9	
	Rated current (A) *7	0.8 (0.8)	1.5 (1.4)	3 (2.5)	5 (4.1)	8 (7)	11 (10)	17.5 (16.5)	24 (23)	33 (31)	47 (44)	60 (57)	
	Overload current rating *3	150% 60s, 200% 3s (inverse-time characteristics)											
Rated voltage *4		Three-phase 200 to 240V											
Regenerative braking torque *5		150%			100%			50%			20%		
Power supply	Rated input AC (DC) voltage/frequency	Three-phase 200 to 240V 50Hz/60Hz (283 to 339VDC *8)											
	Permissible AC (DC) voltage fluctuation	170 to 264V 50Hz/60Hz (240 to 373VDC *8)											
	Permissible frequency fluctuation	±5%											
	Power supply capacity (kVA) *6	0.4	0.8	1.5	2.5	4.5	5.5	9	12	17	20	28	
Protective structure (JEM1030)		Enclosed type (IP20).											
Cooling system		Self-cooling					Forced air cooling						
Approximate mass (kg)		0.5	0.5	0.7	1.0	1.4	1.4	1.7	4.3	4.3	6.5	6.5	

● Three-phase 400V power supply

Model FR-E740-□KSC		0.4	0.75	1.5	2.2	3.7	5.5	7.5	11	15	
Applicable motor capacity (kW) *1		0.4	0.75	1.5	2.2	3.7	5.5	7.5	11	15	
Output	Rated capacity (kVA) *2	1.2	2.0	3.0	4.6	7.2	9.1	13.0	17.5	23.0	
	Rated current (A) *7	1.6 (1.4)	2.6 (2.2)	4.0 (3.8)	6.0 (5.4)	9.5 (8.7)	12	17	23	30	
	Overload current rating *3	150% 60s, 200% 3s (inverse-time characteristics)									
Rated voltage *4		Three-phase 380 to 480V									
Regenerative braking torque *5		100%			50%			20%			
Power supply	Rated input voltage/frequency	Three-phase 380 to 480V 50Hz/60Hz									
	Permissible AC voltage fluctuation	325 to 528V 50Hz/60Hz									
	Permissible frequency fluctuation	±5%									
	Power supply capacity (kVA) *6	1.5	2.5	4.5	5.5	9.5	12	17	20	28	
Protective structure (JEM1030)		Enclosed type (IP20).									
Cooling system		Self-cooling				Forced air cooling					
Approximate mass (kg)		1.4	1.4	1.9	1.9	1.9	3.2	3.2	6.0	6.0	

● Single-phase 200V power supply

Model FR-E720S-□KSC		0.1	0.2	0.4	0.75	1.5	2.2
Applicable motor capacity (kW) *1		0.1	0.2	0.4	0.75	1.5	2.2
Output	Rated capacity (kVA) *2	0.3	0.6	1.2	2.0	3.2	4.4
	Rated current (A) *7	0.8 (0.8)	1.5 (1.4)	3.0 (2.5)	5.0 (4.1)	8.0 (7.0)	11.0 (10.0)
	Overload current rating *3	150% 60s, 200% 3s (inverse-time characteristics)					
Rated voltage *4		Three-phase 200 to 240V					
Regenerative braking torque *5		150%		100%		20%	
Power supply	Rated input AC voltage/frequency	Single-phase 200 to 240V 50Hz/60Hz					
	Permissible AC voltage fluctuation	170 to 264V 50Hz/60Hz					
	Permissible frequency fluctuation	Within ±5%					
	Power supply capacity (kVA) *6	0.5	0.9	1.5	2.5	4.0	5.2
Protective structure (JEM1030)		Enclosed type (IP20)					
Cooling system		Self-cooling			Forced air cooling		
Approximate mass (kg)		0.6	0.6	0.9	1.4	1.5	2.0

- *1 The applicable motor capacity indicated is the maximum capacity applicable for use of the Mitsubishi 4-pole standard motor.
- *2 The rated output capacity assumes the following output voltages: 230V for three-phase 200V/single-phase 200V, and 440V for three-phase 400V.
- *3 The % value of the overload current rating indicated is the ratio of the overload current to the inverter's rated output current. For repeated duty, allow time for the inverter and motor to return to or below the temperatures under 100% load. In a single-phase 200V class inverter with the automatic restart after the instantaneous power failure (*Pr.37*) and the power failure stop (*Pr.261*) functions are set valid, a voltage drop at the power supply and a large load may bring down the bus voltage to the level recognized as a power failure, disabling the inverter to drive a load 100% or higher.
- *4 The maximum output voltage does not exceed the power supply voltage. The maximum output voltage can be changed within the setting range. However, the pulse voltage value of the inverter output side voltage remains unchanged at about $\sqrt{2}$ that of the power supply.
- *5 The braking torque indicated is a short-duration average torque (which varies with motor loss) when the motor alone is decelerated from 60Hz in the shortest time and is not a continuous regenerative torque. When the motor is decelerated from the frequency higher than the base frequency, the average deceleration torque will reduce. Since the inverter does not contain a brake resistor, use the optional brake resistor when regenerative energy is large. A brake unit (FR-BU2) may also be used. (Option brake resistor cannot be used for 0.1K and 0.2K.)
- *6 The power supply capacity varies with the value of the power supply side inverter impedance (including those of the input reactor and cables).
- *7 Setting 2kHz or more in *Pr. 72 PWM frequency selection* to perform low acoustic noise operation with the surrounding air temperature exceeding 40°C, the rated output current is the value in parenthesis.
- *8
 - Connect DC power supply to terminal P/+ and N/- . Connect the plus side of the power supply to terminal P/+ and minus side to terminal N/-.
 - Since the voltage between P/+ and N/- may increase due to the regeneration energy from the motor and exceeds 415V temporarily, select the DC power supply which can withstand the voltage/energy during regeneration. If using the power supply which can not withstand voltage/energy during regeneration, insert diodes in series for reverse current prevention.
 - Although the FR-E700 series has the built-in inrush current limit circuit, select the DC power supply considering the inrush current at powering ON as the inrush current four times of the rated inverter flows at powering ON.
 - Since the power supply capacity depends on the output impedance of the power, select the power supply capacity which has enough allowance according to the AC power supply system capacity.

10.2 Common specifications

Control specifications	Control method		Soft-PWM control/high carrier frequency PWM control (V/F control, Advanced magnetic flux vector control, General-purpose magnetic flux vector control, Optimum excitation control are available)
	Output frequency range		0.2 to 400Hz
	Frequency setting resolution	Analog input	0.06Hz/60Hz (terminal2, 4: 0 to 10V/10-bit) 0.12Hz/60Hz (terminal2, 4: 0 to 5V/9-bit) 0.06Hz/60Hz (terminal4: 0 to 20mA/10-bit)
		Digital input	0.01Hz
	Frequency accuracy	Analog input	Within ±0.5% of the max. output frequency (25°C ±10°C)
		Digital input	Within 0.01% of the set output frequency
	Voltage/frequency characteristics		Base frequency can be set from 0 to 400Hz. Constant-torque/variable torque pattern can be selected
	Starting torque		200% or more (at 0.5Hz)...when Advanced magnetic flux vector control is set (3.7K or lower)
	Torque boost		Manual torque boost
	Acceleration/deceleration time setting		0.01 to 360s, 0.1 to 3600s (acceleration and deceleration can be set individually), linear or S-pattern acceleration/deceleration modes are available.
DC injection brake		Operation frequency (0 to 120Hz), operation time (0 to 10s), operation voltage (0 to 30%) can be changed.	
Stall prevention operation level		Operation current level can be set (0 to 200% adjustable), whether to use the function or not can be selected	
Environment	Surrounding air temperature		-10°C to +50°C (non-freezing) *1
	Ambient humidity		90%RH or less (non-condensing)
	Storage temperature *2		-20°C to +65°C
	Atmosphere		Indoors (without corrosive gas, flammable gas, oil mist, dust and dirt etc.)
	Altitude/vibration		Maximum 1000m above sea level, 5.9m/s ² or less at 10 to 55Hz (directions of X, Y, Z axes)

*1 When using the inverters at the surrounding air temperature of 40°C or less, the inverters can be installed closely attached (0cm clearance).

*2 Temperatures applicable for a short time, e.g. in transit.

10.3 Outline dimension drawings

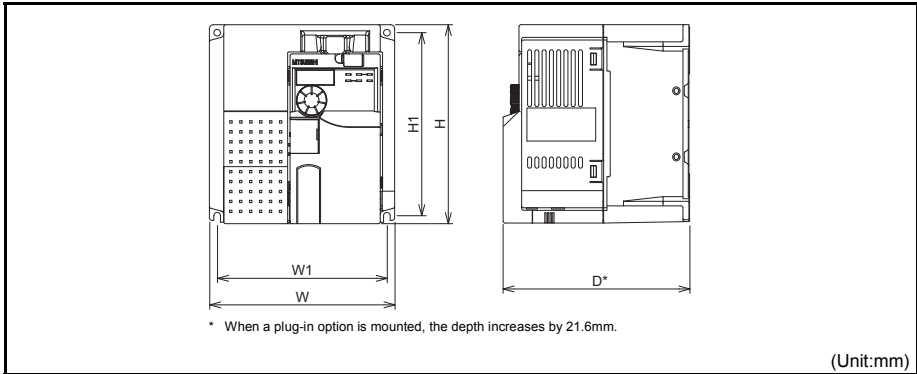

• Three-phase 200V class

Inverter Type	W	W1	H	H1	D
FR-E720-0.1KSC	68	56	128	118	86.5
FR-E720-0.2KSC					118.5
FR-E720-0.4KSC					138.5
FR-E720-0.75KSC					141.5
FR-E720-1.5KSC	108	96	260	244	148.5
FR-E720-2.2KSC	170	158			171
FR-E720-3.7KSC	180	164			196
FR-E720-7.5KSC	220	195			
FR-E720-11KSC					
FR-E720-15KSC					

• Three-phase 400V class

Inverter Model	W	W1	H	H1	D
FR-E740-0.4KSC	140	128	150	138	120
FR-E740-0.75KSC					141
FR-E740-1.5KSC					153
FR-E740-2.2KSC					196
FR-E740-3.7KSC	220	208	260	244	196
FR-E740-5.5KSC					
FR-E740-7.5KSC					
FR-E740-11KSC					
FR-E740-15KSC					

• Single-phase 200V class

Inverter Model	W	W1	H	H1	D
FR-E720S-0.1KSC	68	56	128	118	86.5
FR-E720S-0.2KSC					148.5
FR-E720S-0.4KSC					141.5
FR-E720S-0.75KSC					167
FR-E720S-1.5KSC	108	96	150	138	161.5
FR-E720S-2.2KSC	140	128			

APPENDIX

Appendix 1 Instructions for compliance with the EU Directives

The EU Directives are issued to standardize different national regulations of the EU Member States and to facilitate free movement of the equipment, whose safety is ensured, in the EU territory.

Since 1996, compliance with the EMC Directive that is one of the EU Directives has been legally required. Since 1997, compliance with the Low Voltage Directive, another EU Directive, has been also legally required. When a manufacturer confirms its equipment to be compliant with the EMC Directive and the Low Voltage Directive, the manufacturer must declare the conformity and affix the CE marking.

● The authorized representative in the EU

The authorized representative in the EU is shown below.

Name: Mitsubishi Electric Europe B.V.

Address: Gothaer Strasse 8, 40880 Ratingen, Germany

● Note

We declare that this inverter, when equipped with the dedicated EMC filter, conforms with the EMC Directive in industrial environments and affix the CE marking on the inverter. When using the inverter in a residential area, take appropriate measures and ensure the conformity of the inverter used in the residential area.

(1) EMC Directive

We declare that this inverter, when equipped with the EMC Directive compliant EMC filter, conforms with the EMC Directive and affix the CE marking on the inverter.

- EMC Directive: 2004/108/EC
- Standard(s): EN61800-3:2004 (Second environment / PDS Category "C3")

Note: First environment

Environment including residential buildings. Includes building directly connected without a transformer to the low voltage power supply network which supplies power to residential buildings.

Second environment

Environment including all buildings except buildings directly connected without a transformer to the lower voltage power supply network which supplies power to residential buildings.

● Note

- * Set the EMC Directive compliant EMC filter to the inverter. Insert line noise filters and ferrite cores to the power and control cables as required.
- * Connect the inverter to an earthed power supply.
- * Install a motor, the EMC Directive compliant EMC filter, and a control cable according to the instructions written in the EMC Installation Guidelines (BCN-A21041-204). (Please contact your sales representative for the EMC Installation Guidelines.)
- * The cable length between the inverter and the motor is 5m maximum.
- * Confirm that the final integrated system with the inverter conforms with the EMC Directive.

(2) Low Voltage Directive

We have self-confirmed our inverters as products compliant to the Low Voltage Directive (Conforming standard EN 61800-5-1) and affix the CE marking on the inverters.

● Outline of instructions

- * Do not use an earth leakage circuit breaker as an electric shock protector without connecting the equipment to the earth. Connect the equipment to the earth securely.
- * Wire the earth (ground) terminal independently. (Do not connect two or more cables to one terminal.)
- * Use the cable sizes on *page 13* under the following conditions.
 - Surrounding air temperature: 40°C maximum
 If conditions are different from above, select appropriate wire according to EN60204 ANNEX C TABLE 5.
- * Use a tinned (plating should not include zinc) crimping terminal to connect the earth cable. When tightening the screw, be careful not to damage the threads.
For use as a product compliant with the Low Voltage Directive, use PVC cable on *page 13*.
- * Use the moulded case circuit breaker and magnetic contactor which conform to the EN or IEC Standard.
- * When using an earth leakage circuit breaker, use a residual current operated protective device (RCD) of type B (breaker which can detect both AC and DC). If not, provide double or reinforced insulation between the inverter and other equipment, or put a transformer between the main power supply and inverter.
- * Use the inverter under the conditions of overvoltage category II (usable regardless of the earth (ground) condition of the power supply), overvoltage category III (usable with the earthed-neutral system power supply, 400V class only) specified in IEC664.
- To use the inverter under the conditions of pollution degree 3, install it in the enclosure of IP54 or higher.
- To use the inverter outside of an enclosure in the environment of pollution degree 2, fix a fan cover with fan cover fixing screws enclosed.

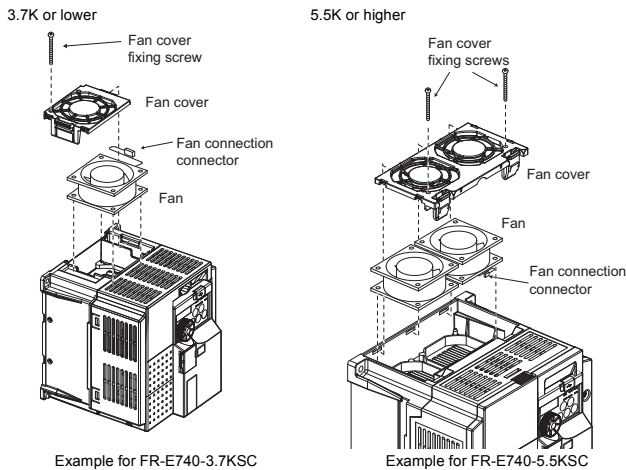

Note, the protection structure of the Inverter units is considered to be an IP00.

- *On the input and output of the inverter, use cables of the type and size set forth in EN60204 Appendix C.
- *The operating capacity of the relay outputs (terminal symbols A, B, C) should be 30VDC, 0.3A. (Relay output has basic isolation from the inverter internal circuit.)
- *Control circuit terminals on *page 9* are safely isolated from the main circuit.
- *Environment

	Running	In Storage	During Transportation
Ambient Temperature	-10°C to +50°C	-20°C to +65°C	-20°C to +65°C
Humidity	90% RH or less	90% RH or less	90% RH or less
Maximum Altitude	1000m	1000m	10000m

Details are given in the technical information "Low Voltage Directive Conformance Guide" (BCN-A21041-203). Please contact your sales representative.

*Select a UL and cUL certified fuse with Class T fuse equivalent cut-off speed or faster with the appropriate rating for branch circuit protection, or a UL489 molded case circuit breaker (MCCB) in accordance with the table below.

FR-E720-□□KSC		0.1	0.2	0.4	0.75	1.5	2.2	3.7	5.5	7.5	11	15
Rated fuse voltage(V)		240V or more										
Fuse Maximum allowable rating (A)*	Without power factor improving reactor	15	15	15	20	30	40	60	70	80	150	175
	With power factor improving reactor	15	15	15	20	20	30	50	60	70	125	150
Molded case circuit breaker (MCCB) Maximum allowable rating (A)*		15	15	15	15	20	25	40	60	80	110	150

FR-E740-□□KSC		0.4	0.75	1.5	2.2	3.7	5.5	7.5	11	15	
Rated fuse voltage(V)		480V or more									
Fuse Maximum allowable rating (A)*	Without power factor improving reactor	6	10	15	20	30	40	70	80	90	
	With power factor improving reactor	6	10	10	15	25	35	60	70	90	
Molded case circuit breaker (MCCB) Maximum allowable rating (A)*		15	15	15	15	20	30	40	50	70	

FR-E720S-□□KSC		0.1	0.2	0.4	0.75	1.5	2.2	
Rated fuse voltage(V)		240V or more						
Fuse Maximum allowable rating (A)*	Without power factor improving reactor	15	20	20	30	40	60	
	With power factor improving reactor	15	20	20	30	30	50	
Molded case circuit breaker (MCCB) Maximum allowable rating (A)*		15	15	15	20	25	40	

* Maximum allowable rating by US National Electrical Code.Exact size must be chosen for each installation.

*When using the electronic thermal relay function as motor overload protection, set the rated motor current to P_r : 9 "Electronic thermal O/L relay".

Electronic thermal relay function operation characteristic

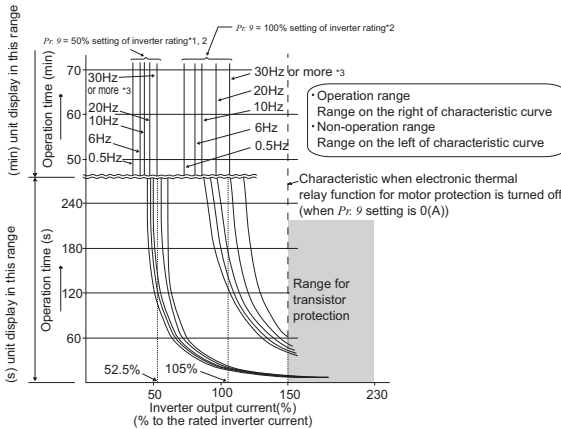

This function detects the overload (overheat) of the motor, stops the operation of the inverter's output transistor, and stops the output. (The operation characteristic is shown on the left.)

When using the Mitsubishi constant-torque motor

- 1) Set "1" or any of "13" to "16", "50", "53", "54" in P_r : 71. (This provides a 100% continuous torque characteristic in the low-speed range.)
- 2) Set the rated current of the motor in P_r : 9.

- *1 When a value 50% of the inverter rated output current (current value) is set in P_r : 9
- *2 The % value denotes the percentage to the inverter rated output current. It is not the percentage to the motor rated current.
- *3 When you set the electronic thermal relay function dedicated to the Mitsubishi constant-torque motor, this characteristic curve applies to operation at 6Hz or higher.

*Short circuit ratings

- 200V class

Suitable For Use in A Circuit Capable of Delivering Not More Than 5 kA rms Symmetrical Amperes, 264 V Maximum.

- 400V class

Suitable For Use in A Circuit Capable of Delivering Not More Than 5 kA rms Symmetrical Amperes, 528 V Maximum.

Appendix 2 Instructions for UL and cUL

(Standard to comply with: UL 508C, CSA C22.2 No. 14)

1. General Precaution

The bus capacitor discharge time is 10 minutes. Before starting wiring or inspection, switch power off, wait for more than 10 minutes, and check for residual voltage between terminal P/+ and N/- with a meter etc., to avoid a hazard of electrical shock.

2. Installation

Inverter have been approved as products for use in enclosure and approval tests were conducted under the following conditions. Design the enclosure so that the surrounding air temperature, humidity and ambience of the inverter will satisfy the above specifications.

Wiring protection

For installation in the United States, branch circuit protection must be provided in accordance with the National Electrical Code and any applicable provincial codes.

For installation in Canada, branch circuit protection must be provided in accordance with the Canadian Electrical Code and any applicable provincial codes. As specified on *page 51*, UL Class T fuses or any faster acting fuse with the appropriate rating or Listed UL 489 Molded Case Circuit Breaker (MCCB) must be employed.

3. Short circuit ratings

• 200V class

Suitable For Use in A Circuit Capable of Delivering Not More Than 100 kA rms Symmetrical Amperes, 264 V Maximum.

• 400V class

Suitable For Use in A Circuit Capable of Delivering Not More Than 100 kA rms Symmetrical Amperes, 528 V Maximum.

4. Wiring

For wiring the input (R/L1, S/L2, T/L3) and output (U, V, W) terminals of the inverter, use the UL Listed copper, stranded wires (rated at 75°C) and round crimping terminals. Crimp the crimping terminals with the crimping tool recommended by the terminal maker.

5. Motor overload protection

When using the electronic thermal relay function as motor overload protection, set the rated motor current to Pr. 9 "Electronic thermal O/L relay". (*Refer to page 51*)



REMARKS

- Safety stop function is not certified by UL.

MEMO

International FA Center



●North American FA Center

MITSUBISHI ELECTRIC AUTOMATION, INC.
500 Corporate Woods Parkway, Vernon Hills, IL60061 U.S.A
TEL. +1-847-478-2100 FAX. +1-847-478-0327

●Korean FA Center

MITSUBISHI ELECTRIC AUTOMATION KOREA CO., LTD.
B1F,2F, 1480-6, Gayang-Dong, Gangseo-Gu, Seoul, 157-200, Korea
TEL. +82-2-3660-9607 FAX. +82-2-3664-0475

●Taiwan FA Center

SETSUYO ENTERPRISE CO., LTD.
6F No.105, Wu Kung 3rd RD, Wu-Ku Hsiang Taipei Hsien, 248, Taiwan
TEL. +886-2-2299-2499 FAX. +886-2-2299-2509

●Beijing FA Center

MITSUBISHI ELECTRIC AUTOMATION (CHINA) LTD. BEIJING OFFICE
9F Office Tower 1, Henderson Center, 18 Jianguomennei Avenue, Dongcheng District, Beijing, China 100005
TEL. +86-10-6518-8830 FAX. +86-10-6518-8030

●Russian FA Center

MITSUBISHI ELECTRIC EUROPE B.V.
-Representative Office in St. Petersburg
Sverdlovskaya Emb.,44, Bld Sch, BC "Benua";195027, St.Petersburg, Russia
TEL. +7-812-633-3496 FAX. +7-812-633-3499

●Tianjin FA Center

MITSUBISHI ELECTRIC AUTOMATION (CHINA) LTD. TIANJIN OFFICE
B-2 801/802, Youyi Building, No.50 Youyi Road, Hexi District, Tianjin, China 300061
TEL. +86-22-2813-1015 FAX. +86-22-2813-1017

●Shanghai FA Center

MITSUBISHI ELECTRIC AUTOMATION (CHINA) LTD.
4/F Zhi Fu Plaza, No.80 Xin Chang Road, Shanghai, China 200003
TEL. +86-21-6121-2460 FAX. +86-21-6121-2424

●Guangzhou FA Center

MITSUBISHI ELECTRIC AUTOMATION (CHINA) LTD. GUANGZHOU OFFICE
Rm.1609, North Tower, The Hub Center, No.1068, Xing Gang East Road, Haizhu District, Guangzhou, China 510335
TEL. +86-20-8923-6713 FAX. +86-20-8923-6715

●Hong Kong FA Center

MITSUBISHI ELECTRIC AUTOMATION (Hong Kong) LTD.
10th Floor, Manulife Tower, 169 Electric Road, North Point, Hong Kong
TEL. +852-2887-8870 FAX. +852-2887-7984

●India FA Center

Mitsubishi Electric Asia Pvt. Ltd. Gurgaon Branch
2nd Floor, DLF Building No.9B, DLF Cyber City Phase III, Gurgaon 122002, Haryana, India
TEL. +91-124-4630300 FAX. +91-124-4630399

●Thailand FA Center

MITSUBISHI ELECTRIC AUTOMATION (THAILAND) CO., LTD.
Bang-Chan Industrial Estate No.111, Soi Serithai 54, T.Kannayao, A.Kannayao, Bangkok 10230
TEL. +66-2-906-3238 FAX. +66-2-906-3239

●ASEAN FA Center

MITSUBISHI ELECTRIC ASIA PTE, LTD.
307 Alexandra Road #05-01/02, Mitsubishi Electric Building, Singapore 159943
TEL. +65-6470-2480 FAX. +65-6476-7439

●European FA Center

MITSUBISHI ELECTRIC EUROPE B. V. GERMAN BRANCH
Gothaer Strasse 8, D-40880 Ratingen, Germany
TEL. +49-2102-486-0 FAX. +49-2102-486-1120

●UK FA Center

MITSUBISHI ELECTRIC EUROPE B. V. UK BRANCH
Travellers Lane, Hatfield, Hertfordshire, AL10 8XB, UK.
TEL. +44-1707-276100 FAX. +44-1707-278695

●Central and Eastern Europe FA Center

MITSUBISHI ELECTRIC EUROPE B.V. CZECH BRANCH
Avenir Business Park, Radlicka 714/113a,158 00 Praha 5, Czech Republic
TEL. +420-251-551-470 FAX. +420-251-551-471

●Brazil FA Center

MELCO-TEC Representacao Comercial e Assessoria Tecnica Ltda.
Av. Paulista 1439, conj.74, Bela Vista CEP: 01311-200 Sao Paulo-SP-Brazil
TEL. +55-11-3146-2202 FAX. +55-11-3146-2217



MITSUBISHI ELECTRIC CORPORATION

HEAD OFFICE: TOKYO BUILDING 2-7-3, MARUNOUCHI, CHIYODA-KU, TOKYO 100-8310, JAPAN